

Pricelist.

Lounge and Residence Hall Furniture

**PRICES SHOWN
ARE LIST ONLY**

Contact your local
Representative or Blockhouse
@ 1-800-346-1126 for
appropriate discount.
(Net selling price is calculated by
applying discount to list price.)



Blockhouse Contract Furniture Company

3285 Farmtrail Road • York, PA 17406 • 800.346.1126 • fax: 717.767.8939 • e-mail: marketing@blockhouse.com

www.blockhouse.com

PL# 1013

Table of Contents

Warranty	4	Option Selection	29-30
General Information	5-6	Modular Seating (Paragon)	27
X-Chair Seating	7-11	Option Selection	29-30
Option Selection	12	Specialty Seating (Safety Support, Silhouette)	28
Full Sized Wood Frame Lounge Seating	13-18	Option Selection	29-30
Endurance	13	Tables (Dining, Study, Activity)	31-34
Provident	13	Table Tops	31
Endurance Traditional	14	Table Bases	32-34
Endurance Rocker	14	Option Selection	35
Bravura	14	Occasional & Modular Tables	36-39
Orion	15	Option Selection	40
Sedona	15	Casegoods	41-51
Mesa	15-16	C9	41-45
Arcadia	16	Option Selection	52-53
Synergy	16-17	CS	46-47
Tucson	17-18	Vista	47-48
Option Selection	29-30	Option Selection	52-53
Bench Seating	18-19	Spartan	49-51
Option Selection	29-30	Option Selection	52-53
Fully Upholstered Lounge Seating	21-23	Assemblies/Parts	54-69
Ambassador	21-22	Casegoods Assemblies & Parts	54-56
Aries	23	Lounge Seating Assemblies & Parts	57-65
Regent	23	Option Selection	66-67
Option Selection	23-30	X Chair Assemblies & Parts	68-69
Living Room Seating	19-21, 24-26	Option Selection	70
Eros	19	Freight Chart	72
Sabre	20		
Tarvos	20		
Estel	21		
Bristol	21		
Malibu	24		
Casual Comfort Straight Arm	24		
Casual Comfort Rolled Arm	25		
Aurora	25		
Haley	26		
Pomona	26		

RIGHTS AND WARRANTIES

The following Blockhouse product warranty applies to products manufactured by Blockhouse and/or distributed from our manufacturing site in York, Pennsylvania effective May 1, 2009. This warranty is given to the initial purchaser and is valid for as long as the initial purchaser owns the product. The warranty, which runs from the date of manufacture, covers defects in materials and craftsmanship found during normal usage of the products during the warranty period. If a product is defective, and if written notice of the defect is given to Blockhouse within the applicable warranty period, Blockhouse at its option will either repair or replace the defective product with a comparable component or product.

LIMITED LIFETIME WARRANTY

The Limited Lifetime Warranty applies to normal useful life in a typical multi-use environment unless specified as an exception. This warranty does not apply to damage caused by carrier, alterations to product not expressly authorized by Blockhouse, nor to products considered to be of a consumable nature such as fabrics, foam and related products. It also does not apply to "Customer's Own Material" (i.e., material supplied by the Customer that is not a standard Blockhouse product offering) used in the manufacture of Blockhouse products. Blockhouse does not warranty the matching of color, grain or texture, except to within commercially acceptable standards. A product will not be considered defective, and Blockhouse will not be obligated to replace it, if the product is subject to any of Blockhouse's written planning, installation or user guides, and is not installed or used as recommended therein.

EXCEPT AS STATED ABOVE, BLOCKHOUSE MAKES NO EXPRESS OR IMPLIED WARRANTIES AS TO ANY PRODUCT AND IN PARTICULAR MAKES NO WARRANTY OF FITNESS FOR ANY PARTICULAR USE. AT BLOCKHOUSE'S OPTION, PRODUCT REPAIR, REPLACEMENT IS THE CUSTOMER'S EXCLUSIVE REMEDY FOR ANY AND ALL PRODUCT DEFECTS.

Blockhouse will not be liable for consequential, economic, or incidental damages arising from any product defect.

PRICES	This price list supersedes all previous lists. Any items not listed here have been discontinued. Prices shown in this catalog are list, subject to change without notice. Contact factory or your sales representative for discounted net prices.
TERMS	1/10 net 30 to approved account; cash with order or a deposit required if credit has not been cleared at time of order. Delinquent customers are liable for all collection costs and all attorney fees.
SHIPPING & ROUTING	F.O.B. York, PA. Blockhouse traffic department will route shipments by best carrier to take advantage of lowest available rates. A loading/handling fee will be charged if customer selects carrier or arranges pick-up. A charge of 10% of the freight cost will be added to all prepaid freight invoices.
MEASUREMENTS	ALL DIMENSIONS ARE APPROXIMATE. All weights given are approximate unpacked weight. Specified cubes are based on actual load conditions, not necessarily measurement. We reserve the right to make modifications as needed for general improvement of product.
CLAIMS	All furniture is shipped at purchaser's risk after it is carefully inspected, securely packed and turned over to the carrier; merchandise would not be accepted by carrier unless it were in good condition. Before accepting goods from the carrier YOU MUST EXAMINE SHIPMENT CAREFULLY. All claims should be filed immediately with delivery carrier; other adjustments will be considered only if filed immediately with delivery carrier; other adjustments will be considered only if filed with us in writing within five (5) days after arrival of shipment.
STORAGE	Customer delivery postponement of product ready for shipment within standard production times will be placed into storage at customer expense. Storage charges will be invoiced monthly and due for payment within ten (10) days.
RETURNS	Merchandise will not be accepted for return unless approved by us in writing by the issuance of an RMA.
CANCELLATIONS/REVISIONS	A 25% restocking fee for stock items and 50% restocking fee for non-stock items will apply to the entire order or line item(s) if revised or cancelled after five (5) days of receipt of purchase order and our acknowledgement of your order.
DELIVERIES	Deliveries are contingent on strikes, fires, accidents, and other causes beyond our control; we will not be liable for damages resulting from delays in delivery due to any cause whatsoever.
CARTONING & CRATING	All items requiring cartoning and/or crating will carry an up-charge (see footnotes with specific products).
SPECIAL SIZES & STYLES	Blockhouse will consider for production, items not listed in the Price List. A \$1000. net price set-up charge will be applied to the order to cover engineering and design expenses.
CUSHION CONSTRUCTION	Standard cushioning is a durable and comfortable combination of softex wrapped polyurethane supported by a heavy-duty spring unit, unless otherwise described.
FIRE RETARDANT OPTIONS	All Blockhouse upholstered seating passes, as a minimum, California Technical Bulletin #117. Optional fire retardant standards, such as California TB#133, can be met or exceeded with applicable surcharge (see Option Selection at the end of each section). Ask your Blockhouse representative for details, or call Customer Service at 1-800-346-1126.
C.O.M. YARDAGE	Yardage required is based on 54" plain. For fabrics with patterns or prints requiring matching, contact factory for yardage required. Send all C.O.M. fabrics directly to factory at: 3285 Farmtrail Road, York, PA 17406.
CATALOG	Presentation of this catalog and/or price list is for information only and does not constitute an obligation to sell.

Ordering Check List

So that your order can be processed and delivered quickly and accurately, please take a minute and check if you have specified:

- Delivery address (street address including zip code, contact person, and phone).
- Quantities of each item. Correct price including any applicable charges.
- Any special instructions.

Please...Double check your purchase order so that we can serve you better.

Fabric Grades

This price list specifies eleven grades of fabric as follows:

Grade	List Price (per yard)	Grade	List Price (per yard)	Grade	List Price (per yard)
A (Consult Factory)	49.	E (Consult Factory)	179.	I (Consult Factory)	385.
B (Consult Factory)	77.	F (Consult Factory)	234.	J (Consult Factory)	436.
C (Consult Factory)	108.	G (Consult Factory)	280.	K (Consult Factory)	489.
D (Consult Factory)	129.	H (Consult Factory)	333.		

Fire Retardant Standards

All Blockhouse upholstered seating passes, as a minimum, California Technical Bulletin #117. Optional fire retardant standards - such as **California TB#133** - can be met or exceeded with applicable surcharge (see Option Selections at the end of each section).

Ask your Blockhouse representative for details, or call Customer Service as **1-800-346-1126**.

A leader in providing fire retardant furniture for institutional environments since 1971.

Wood Species and Finishes

Product	Wood Species	Code	Standard Finish	Code
Lounge Seating, Tables and C9, CS, Vista,	Red Oak	1	Natural	A

Standard finish will be applied unless otherwise specified.



Available Blockhouse Finishes

Name	Selection	Additional Charge	Name	Selection	Additional Charge
Natural	A	No charge.	English Oak	K	See Option Selection at end of each section.
Golden Oak	B	See Option Selection at end of each section.	Honey Oak	L	See Option Selection at end of each section.
Bengal Teak	D	See Option Selection at end of each section.	Smoke	M	See Option Selection at end of each section.
Wild Cherry	F	See Option Selection at end of each section.	Sweet Cherry	N	See Option Selection at end of each section.
Windsor Mahogany	G	See Option Selection at end of each section.	Custom Matched*	X	See Option Selection at end of each section.

**Minimum Charge = \$888. list*

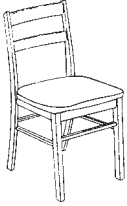

Field Description:		Class Type	Product Line	Shape	N/A	# of Seats	Upholstery Type	Foam Options	N/A	Fabric Grade	Fabric Pattern	Wood Type	Finish	Special							
Field Position:		1	2	3	4	5	6	7	8	9	10	11	12	13	14	15	16	17	18	19	20
		X	0	0	0	0	0	0	-	0	0	00	-	X	000	0	X	0			

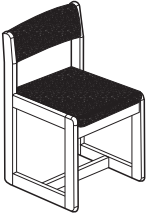
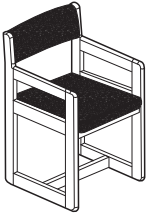
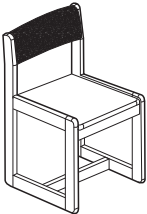
X Chair Seating

	Model/Description	Dimensions	SH	AH	Ydg.	Wt	List Price
	X024101-0000-00001A0 Wood Library Chair Wood back, wood seat, oak, natural finish	17W 21D 32H 7.4 cu. ft.	18½			17	338
	X025101-2100-****1A0 Upholstered Wood Library Chair Upholstered seat, Cal 117 foam, oak, natural finish	17W 21D 32H 7.4 cu. ft.	18½		½	17	A 477 B 491 C 506 D 517 E 543 F 569
	X028101-0000-00001A0 Wood Spindle Back Side Chair Oak, natural finish	20W 21½D 37¾H 10.6 cu. ft.	17½			18	399
	X030101-1100-****1A0 Upholstered Side Chair Sled base, upholstered seat, upholstered back, Cal 117 foam, oak, natural finish	20W 19½D 31H 8 cu. ft.	19		¾	20	A 446 B 466 C 488 D 503 E 541 F 579
	X030201-1100-****1A0 Upholstered Arm Chair Sled base, upholstered seat, upholstered back, Cal 117 foam, oak, natural finish	20W 19½D 31H 8 cu. ft.	19	24	¾	25	A 458 B 477 C 499 D 514 E 553 F 591
	X031101-3100-****1A0 Upholstered Side Chair Sled base, wood seat, upholstered back, Cal 117 foam, oak, natural finish	20W 19½D 31H 8 cu. ft.	17		½	20	A 446 B 459 C 473 D 484 E 509 F 534

An underlined character indicates there is a choice available. See page 12 for selections and pricing. **** means that a fabric selection is required. List price for C.O.M. material is the same as Grade B. Cartoning charges: Add \$44 to list price per each cartoned X chair.

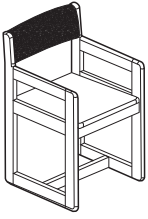
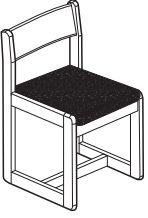
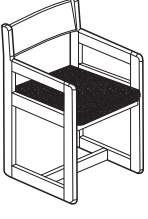
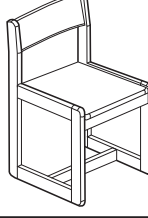
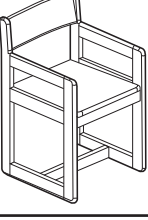
X Chair Seating

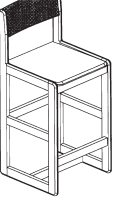
	Model/Description	Dimensions	SH	AH	Ydg.	Wt	List Price
	X031201-3100-****1<u>A</u>0 Upholstered Arm Chair Sled base, wood seat, upholstered back, Cal 117 foam, oak, natural finish	20W 19½D 31H 8 cu. ft.	17	24½	½	25	A 484 B 497 C 511 D 522 E 546 F 572
	X032101-2100-****1<u>A</u>0 Upholstered Side Chair Sled base, wood back, upholstered seat, Cal 117 foam, oak, natural finish	20W 19½D 31H 8 cu. ft.	19		½	20	A 433 B 446 C 461 D 471 E 497 F 522
	X032201-2100-****1<u>A</u>0 Upholstered Arm Chair Sled base, wood back, upholstered seat, Cal 117 foam, oak, natural finish	20W 19½D 31H 8 cu. ft.	19	24½	½	25	A 470 B 483 C 498 D 508 E 533 F 559
	X033101-0000-00001<u>A</u>0 Wood Side Chair Sled base, wood seat, wood back, oak, natural finish	20W 19½D 31H 8 cu. ft.	17			20	439
	X033201-0000-00001<u>A</u>0 Wood Arm Chair Sled base, wood seat, wood back, oak, natural finish	20W 19½D 31H 8 cu. ft.	17	24½		25	458
	X034101-1100-****1<u>A</u>0 Upholstered Barstool Sled base, upholstered seat, upholstered back, Cal 117 foam, oak, natural finish	20W 19½D 43H 11 cu. ft.	31		¾	36	A 580 B 600 C 622 D 637 E 675 F 713
	X035101-3100-****1<u>A</u>0 Upholstered Barstool Sled base, wood seat, upholstered back, Cal 117 foam, oak, natural finish	20W 19½D 43H 11 cu. ft.	29		½	36	A 572 B 585 C 600 D 610 E 635 F 660

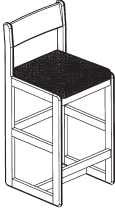
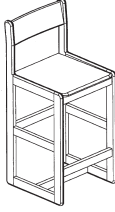
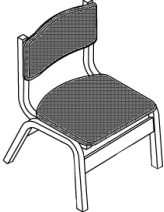
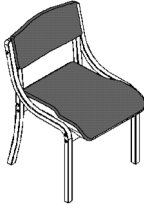
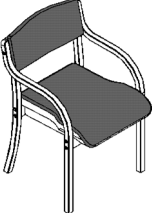
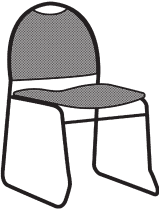
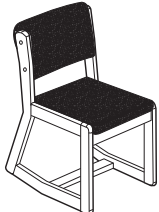

An underlined character indicates there is a choice available. See page 12 for selections and pricing. **** means that a fabric selection is required. List price for C.O.M. material is the same as Grade B. Cartoning charges: Add \$44 to list price per each cartoned X chair.

X Chair Seating

	Model/Description	Dimensions	SH	AH	Ydg.	Wt	List Price
	X036101-2100-****1A0 Upholstered Barstool Sled base, upholstered seat, wood back, Cal 117 foam, oak, natural finish	20W 19½D 43H 11 cu. ft.	31		½	36	A 560 B 572 C 587 D 597 E 623 F 647
	X037101-0000-00001A0 Wood Barstool Sled base, wood seat, wood back, oak, natural finish	20W 19½D 43H 11 cu. ft.	29			36	560
	X043101-1100-****1A0 Leg Base Chair Upholstered seat, upholstered back, Cal 117 foam, oak, natural finish	20W 23D 32H 9.7 cu. ft.	18		¾	18	A 333 B 352 C 373 D 388 E 425 F 462
	X045101-1100-****1A0 Bentply Stack Chair Upholstered seat, upholstered back, Cal 117 foam, oak, natural finish	20½W 22½D 32½H 9.8 cu. ft.	18½		¾	18	A 450 B 469 C 491 D 507 E 544 F 582
	X045201-1100-****1A0 Bentply Stack Chair with Arms Upholstered seat, upholstered back, Cal 117 foam, oak, natural finish	20½W 22½D 32½H 9.8 cu. ft.	18½	25½	¾	18	A 450 B 469 C 491 D 507 E 544 F 582
	X050101-1100-****000 Metal Stack Chair Sled base, upholstered seat, upholstered back, Cal 117 foam, steel, black finish	20W 22D 32H 9.3 cu. ft.	18		1	14	A 253 B 278 C 307 D 328 E 379 F 429
	X060101-1100-****1A0 Two-position Side Chair Upholstered seat, upholstered back, Cal 117 foam, oak, natural finish	20W 25D 31H 10.2 cu. ft.	17½		¾	20	A 712 B 737 C 765 D 785 E 834 F 884

An underlined character indicates there is a choice available. See page 12 for selections and pricing. **** means that a fabric selection is required. List price for C.O.M. material is the same as Grade B. Cartoning charges: Add \$44 to list price per each cartoned X chair.

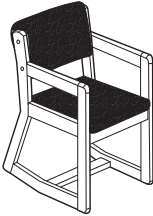
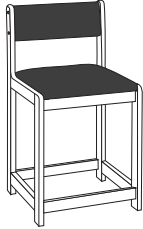
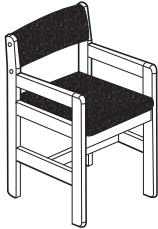
X Chair Seating

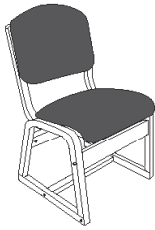

	Model/Description	Dimensions	SH	AH	Ydg.	Wt	List Price
	X060201-1100-****1A0 Two-position Arm Chair Upholstered seat, upholstered back, Cal 117 foam, oak, natural finish	20W 25D 31H 10.2 cu. ft.	18½	24½	¾	25	A 760 B 785 C 813 D 833 E 882 F 931
	X064101-1100-****1A0 Upholstered Barstool Leg base, upholstered seat, upholstered back, Cal 117 foam, oak, natural finish	20W 20¾D 37½H 9.5 cu. ft.	25		¾	33	A 546 B 565 C 585 D 599 E 635 F 671
	X070201-1100-****1A0 Upholstered Arm Chair Upholstered seat, upholstered back, Cal 117 foam, oak, natural finish	20W 19½D 31H 8 cu. ft.	19	24½	¾	25	A 444 B 463 C 484 D 499 E 536 F 573
	X074101-1100-****1A0 Upholstered Barstool Leg base, upholstered seat, upholstered back, Cal 117 foam, oak, natural finish	20W 20¾D 43½H 11.8 cu. ft.	31		¾	33	A 563 B 582 C 603 D 618 E 655 F 692
	X140101-1100-****1A0 Two-position Desk Chair Upholstered seat, upholstered back, Cal 117 foam, oak, natural finish	20W 23D 32H 9.7 cu. ft.	18		¾	18	A 353 B 372 C 393 D 408 E 445 F 482
	X142101-1100-****1A0 Sled Base Chair Upholstered seat, upholstered back, Cal 117 foam, oak, natural finish	20W 23D 32H 9.7 cu. ft.	18		¾	18	A 353 B 372 C 393 D 408 E 445 F 482

An underlined character indicates there is a choice available. See page 12 for selections and pricing. **** means that a fabric selection is required. List price for C.O.M. material is the same as Grade B. Cartoning charges: Add \$44 to list price per each cartoned X chair.

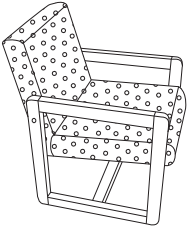
X Chair Seating

	Model/Description	Dimensions	SH	AH	Ydg.	Wt	List Price
	L240201-0100-****1A0 Desk/Lounge Chair Upholstered seat, upholstered back, Cal 117 foam, oak, natural finish	22W 25½D 32¼H 10.2 cu. ft.	17½	22½	1½	25	A 924 B 963 C 1008 D 1040 E 1117 F 1194

Vista Chairs

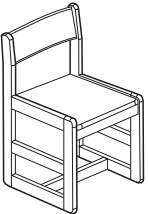
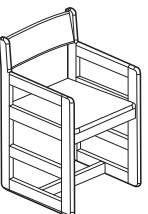
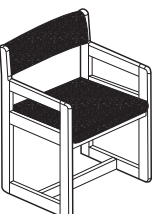
	X130101-1100-****1A0 Upholstered Side Chair Upholstered seat, upholstered back, Cal 117 foam, oak, natural finish, reinforced sled base frame	20W 19½D 31H 8 cu. ft.	19		¾	25	A 663 B 683 C 704 D 721 E 758 F 795
	X130201-1100-****1A0 Upholstered Arm Chair Upholstered seat, upholstered back, Cal 117 foam, oak, natural finish, reinforced sled base frame	20W 19½D 31H 8 cu. ft.	19	24½	¾	30	A 709 B 729 C 750 D 765 E 803 F 841
	X133101-0000-00001A0 Wood Side Chair Wood seat, wood back, oak, natural finish, reinforced sled base frame	20W 19½D 31H 8 cu. ft.	17½			25	663
	X133201-0000-00001A0 Wood Arm Chair Wood seat, wood back, oak, natural finish, reinforced sled base frame	20W 19½D 31H 8 cu. ft.	17½	24½		30	709
	L930201-0100-****1A0 Bariatric Chair Upholstered seat, upholstered back, Cal 117 foam, oak, natural finish, sled base, 1000 lbs weight capacity	30½W 27D 32½H 17.1 cu. ft.	20	25½	2	45	A 1188 B 1237 C 1296 D 1335 E 1433 F 1530

An underlined character indicates there is a choice available. See page 12 for selections and pricing. **** means that a fabric selection is required. List price for C.O.M. material is the same as Grade B. Cartoning charges: Add \$44 to list price per each cartoned X chair.

X Chair Option Selection & Pricing Guide

Field Description: **Foam (per set)**
 Field Position: **10**
 Selection Description:
 Selection #:

N/A	Cal 117	Cal 117, m.r.* Seat	Cal 117, m.r.* Seat & Back	Cal 133	Cal 133, m.r.* Seat	Cal 133, m.r.* Seat & Back
0	1	2	3	4	5	6

Field Description: **Finish**
 Field Position: **19**
 Selection Description:
 Selection #:

N/A	Natural	Stock Finish	Custom Match (sample required) (Min \$403.60)
0	A	B-N	X

X024101
X025101
X028101
X030101
X030201
X031101
X031201
X032101
X032201
X033101
X033201
X034101
X035101
X036101
X037101
X043101
X045101
X045201
X050101
X060101
X060201
X064101
X070201
X074101
X130101
X130201
X133101
X133201
X140101
X142101
L240201
L930201

S						
	S	+42		+36	+78	
S						
	S	+42	+84	+66	+108	+150
	S	+42	+84	+66	+108	+150
	S		+42	+36		+78
	S		+42	+36		+78
	S	+42		+36	+78	
	S	+42		+36	+78	
S						
S						
	S	+42	+84	+66	+108	+150
	S		+42	+36		+78
	S	+42		+36	+78	
S						
	S	+42	+84	+66	+108	+150
	S	+42	+84	+66	+108	+150
	S	+42	+84	+66	+108	+150
	S	+42	+84	+66	+108	+150
	S	+42	+84	+66	+108	+150
	S	+42	+84	+66	+108	+150
	S	+42	+84	+66	+108	+150
	S	+42	+84	+66	+108	+150
S						
S						
	S	+42	+80	+66	+108	+150
	S	+42	+80	+66	+108	+150
S		+80	+160	+123	+203	+283

	S	+97	+162
	S	+97	+162
	S		
	S	+97	+162
	S	+97	+162
	S	+97	+162
	S	+97	+162
	S	+97	+162
	S	+97	+162
	S	+97	+162
	S	+97	+162
	S	+97	+162
	S	+97	+162
	S	+97	+162
	S	+97	+162
	S		
	S		
	S		
		+97	+162
		+97	+162
		+97	+162
		+97	+162
		+97	+162
		+97	+162
		+97	+162
		+97	+162
S		+97	+194
S		+97	+194
S		+97	+194
	S		
	S		
S		+92	+194

*m.r. = Moisture resistance

Field Description:		Class Type	Product Line	Edge	Back Panel	# of Seats	Cushion Type	Foam Options	Options/Accessories	Fabric Grade	Fabric Pattern	Wood Type	Finish	Special							
Field Position:		1	2	3	4	5	6	7	8	9	10	11	12	13	14	15	16	17	18	19	20
		L1	00	0	0	0	-	X	0	00	-	X	000	0	X	0					

Full Sized Wood Frame Lounge Seating

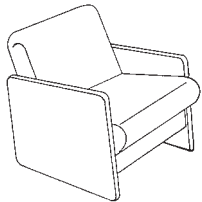
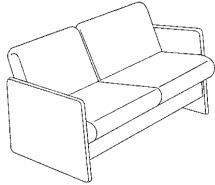
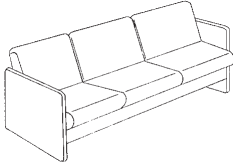
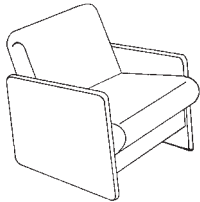
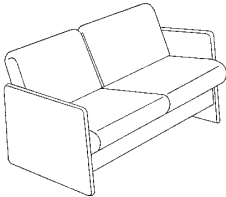
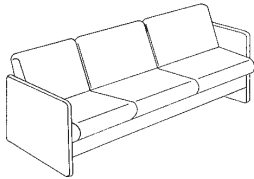
	Model/Description	Dimensions	SH	AH	Ydg.	Wt	List Price
	L110111-A100-****1A0 Endurance, Lounge Chair Butcher block ends and back panel, bull nosed edge, Key-Loc® reversible cushions, Cal 117 foam, oak, natural finish	27½W 32D 29½H 16.6 cu. ft.	16¾	20½	2	100	A 1331 B 1381 C 1441 D 1482 E 1583 F 1684
	L110112-A100-****1A0 Endurance, Loveseat Butcher block ends and back panel, bull nosed edge, Key-Loc® reversible cushions, Cal 117 foam, oak, natural finish	52W 32D 29½H 30.9 cu. ft.	16¾	20½	4	145	A 2172 B 2275 C 2399 D 2481 E 2685 F 2891
	L110113-A100-****1A0 Endurance, Sofa Butcher block ends and back panel, bull nosed edge, Key-Loc® reversible cushions, Cal 117 foam, oak, natural finish	76½W 32D 29½H 45.2 cu. ft.	16¾	20½	6	190	A 2988 B 3142 C 3326 D 3450 E 3757 F 4066
	L110121-A100-****1A0 Provident, Lounge Chair Butcher block ends, wood rail backs, bull nosed edge, Key-Loc® reversible cushions, Cal 117 foam, oak, natural finish	27½W 32D 29½H 16.6 cu. ft.	16¾	20½	2	90	A 1242 B 1292 C 1353 D 1393 E 1493 F 1594
	L110122-A100-****1A0 Provident, Loveseat Butcher block ends, wood rail backs, bull nosed edge, Key-Loc® reversible cushions, Cal 117 foam, oak, natural finish	52W 32D 29½H 30.9 cu. ft.	16¾	20½	4	130	A 2068 B 2171 C 2295 D 2377 E 2581 F 2787
	L110123-A100-****1A0 Provident, Sofa Butcher block ends, wood rail backs, bull nosed edge, Key-Loc® reversible cushions, Cal 117 foam, oak, natural finish	76½W 32D 29½H 45.2 cu. ft.	16¾	20½	6	170	A 2810 B 2965 C 3148 D 3272 E 3580 F 3889

An underlined character indicates there is a choice available. See page 29-30 for selections and pricing. **** means that a fabric selection is required. List price for C.O.M. material is the same as Grade B. Cartoning charges: Add \$74 to list price per each cartoned lounge chair; Add \$92 to list price per each cartoned loveseat; Add \$116 to list price per each cartoned sofa; Add 10% to list price per any other cartoned lounge seating item.

Full Sized Wood Frame Lounge Seating

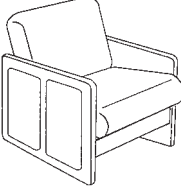
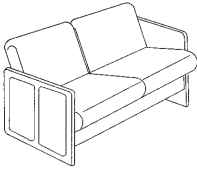
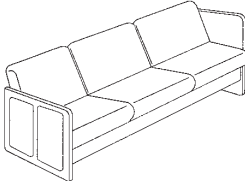
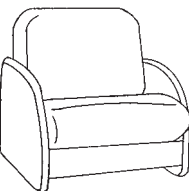
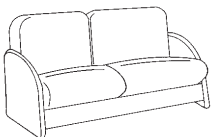
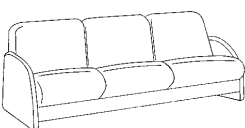
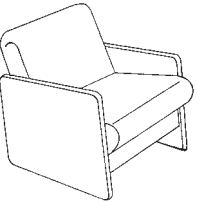
	Model/Description	Dimensions	SH	AH	Ydg.	Wt	List Price
	L111111-A100-****1A0 Endurance, Traditional Lounge Chair Butcher block ends and back panel, bull nosed edge, Key-Loc® reversible cushions, Cal 117 foam, oak, natural finish	27½W 32D 29½H 16.6 cu. ft.	16¾	20½	2	100	A 1422 B 1472 C 1533 D 1573 E 1674 F 1775
	L111112-A100-****1A0 Endurance, Traditional Loveseat Butcher block ends and back panel, bull nosed edge, Key-Loc® reversible cushions, Cal 117 foam, oak, natural finish	52W 32D 29½H 30.9 cu. ft.	16¾	20½	4	145	A 2263 B 2366 C 2489 D 2571 E 2777 F 2981
	L111113-A100-****1A0 Endurance, Traditional Sofa Butcher block ends and back panel, bull nosed edge, Key-Loc® reversible cushions, Cal 117 foam, oak, natural finish	76½W 32D 29½H 45.2 cu. ft.	16¾	20½	6	190	A 3085 B 3240 C 3423 D 3547 E 3856 F 4164
	L112111-A100-****1A0 Bravura, Lounge Chair Butcher block ends and back panel, bull nosed edge, Key-Loc® reversible cushions, Cal 117 foam, oak, natural finish	27½W 32D 29½H 16.6 cu. ft.	16¾	20½	2	95	A 1331 B 1381 C 1441 D 1482 E 1583 F 1684
	L112112-A100-****1A0 Bravura, Loveseat Butcher block ends and back panel, bull nosed edge, Key-Loc® reversible cushions, Cal 117 foam, oak, natural finish	52W 32D 29½H 30.9 cu. ft.	16¾	20½	4	140	A 2172 B 2275 C 2399 D 2481 E 2685 F 2891
	L112113-A100-****1A0 Bravura, Sofa Butcher block ends and back panel, bull nosed edge, Key-Loc® reversible cushions, Cal 117 foam, oak, natural finish	76½W 32D 29½H 45.2 cu. ft.	16¾	20½	6	185	A 2978 B 3133 C 3316 D 3440 E 3748 F 4057
	L115111-A100-****1A0 Endurance, Rocker Butcher block ends and back panel, heavy duty rocker mechanism, bull nosed edge, Key-Loc® reversible cushions, Cal 117 foam, oak, natural finish	28W 34D 30H 18.2 cu. ft.	16¾	20½	2	115	A 2025 B 2077 C 2140 D 2181 E 2285 F 2389

An underlined character indicates there is a choice available. See page 29-30 for selections and pricing. **** means that a fabric selection is required. List price for C.O.M. material is the same as Grade B. Cartoning charges: Add \$74 to list price per each cartoned lounge chair; Add \$92 to list price per each cartoned loveseat; Add \$116 to list price per each cartoned sofa; Add 10% to list price per any other cartoned lounge seating item.

Full Sized Wood Frame Lounge Seating

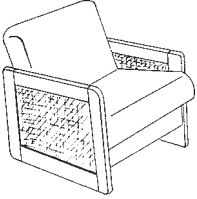
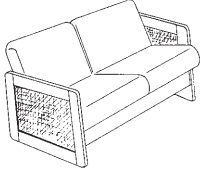
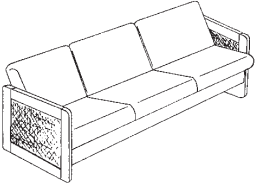
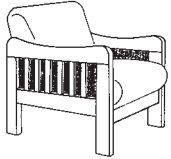
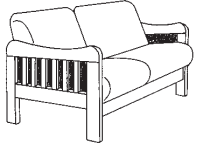
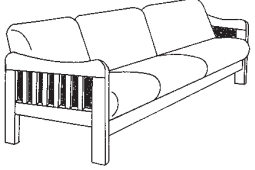
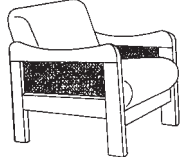
	Model/Description	Dimensions	SH	AH	Ydg.	Wt	List Price
	L119231-A100-****1A0 Orion, Lounge Chair Upholstered inserts in end panels, wood rail back, eased edge, Key-Loc® reversible cushions, Cal 117 foam, oak, natural finish	28W 33D 30H 17.7 cu. ft.	16¾	22½	3½	85	A 1484 B 1573 C 1680 D 1753 E 1932 F 2113
	L119232-A100-****1A0 Orion, Loveseat Upholstered inserts in end panels, wood rail back, eased edge, Key-Loc® reversible cushions, Cal 117 foam, oak, natural finish	52½W 33D 30H 32.7 cu. ft.	16¾	22½	5½	125	A 2285 B 2426 C 2596 D 2708 E 2991 F 3273
	L119233-A100-****1A0 Orion, Sofa Upholstered inserts in end panels, wood rail back, eased edge, Key-Loc® reversible cushions, Cal 117 foam, oak, natural finish	77W 33D 30H 47.6 cu. ft.	16¾	22½	7½	165	A 3065 B 3259 C 3490 D 3643 E 4028 F 4414
	L120121-A100-****1A0 Sedona, Lounge Chair Upholstered insert panels with slats in ends, bull nosed edge with saddle arm, wood rail back, Key-Loc® reversible cushions, Cal 117 foam, oak, natural finish	28W 33D 31H 18.3 cu. ft.	18	23¾	3	80	A 1371 B 1447 C 1540 D 1602 E 1756 F 1909
	L120122-A100-****1A0 Sedona, Loveseat Upholstered insert panels with slats in ends, bull nosed edge with saddle arm, wood rail back, Key-Loc® reversible cushions, Cal 117 foam, oak, natural finish	52½W 33D 31H 33.7 cu. ft.	18	23¾	5	120	A 2244 B 2372 C 2527 D 2630 E 2886 F 3143
	L120123-A100-****1A0 Sedona, Sofa Upholstered insert panels with slats in ends, bull nosed edge with saddle arm, wood rail back, Key-Loc® reversible cushions, Cal 117 foam, oak, natural finish	77W 33D 31H 49.2 cu. ft.	18	23¾	7	160	A 2982 B 3163 C 3378 D 3522 E 3881 F 4240
	L121121-A100-****1A0 Mesa, Lounge Chair Upholstered insert panels in ends, bull nosed edge with saddle arm, wood rail back, Key-Loc® reversible cushions, Cal 117 foam, oak, natural finish	28W 33D 31H 18.3 cu. ft.	18	23¾	3	80	A 1340 B 1417 C 1509 D 1571 E 1726 F 1879

An underlined character indicates there is a choice available. See page 29-30 for selections and pricing. **** means that a fabric selection is required. List price for C.O.M. material is the same as Grade B. Cartoning charges: Add \$74 to list price per each cartoned lounge chair; Add \$92 to list price per each cartoned loveseat; Add \$116 to list price per each cartoned sofa; Add 10% to list price per any other cartoned lounge seating item.

Full Sized Wood Frame Lounge Seating

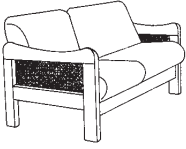
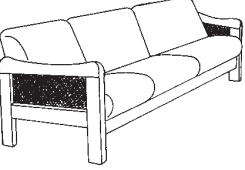
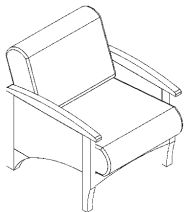
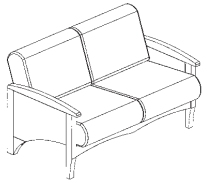
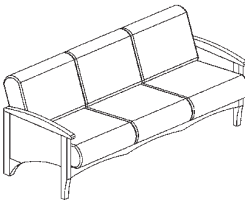
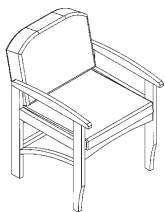
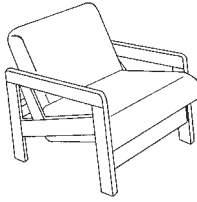
	Model/Description	Dimensions	SH	AH	Ydg.	Wt	List Price
	L121122-A100-****1A0 Mesa, Loveseat Upholstered insert panels in ends, bull nosed edge with saddle arm, wood rail back, Key-Loc® reversible cushions, Cal 117 foam, oak, natural finish	52½W 33D 31H 33.7 cu. ft.	18	23¾	5	120	A 2202 B 2330 C 2485 D 2588 E 2844 F 3101
	L121123-A100-****1A0 Mesa, Sofa Upholstered insert panels in ends, bull nosed edge with saddle arm, wood rail back, Key-Loc® reversible cushions, Cal 117 foam, oak, natural finish	77W 33D 31H 49.2 cu. ft.	18	23¾	7	160	A 2937 B 3117 C 3333 D 3476 E 3836 F 4195
	L124221-A100-****1A0 Arcadia, Lounge Chair Upholstered insert panels in ends, eased edges, wood rail back, Key-Loc® reversible cushions, Cal 117 foam, oak, natural finish	28W 33D 31H 18.3 cu. ft.	20	24	3½	80	A 1458 B 1548 C 1655 D 1728 E 1907 F 2087
	L124222-A100-****1A0 Arcadia, Loveseat Upholstered insert panels in ends, eased edges, wood rail back, Key-Loc® reversible cushions, Cal 117 foam, oak, natural finish	52½W 33D 31H 33.7 cu. ft.	20	24	5½	120	A 2285 B 2426 C 2596 D 2708 E 2991 F 3273
	L124223-A100-****1A0 Arcadia, Sofa Upholstered insert panels in ends, eased edges, wood rail back, Key-Loc® reversible cushions, Cal 117 foam, oak, natural finish	77W 33D 31H 49.2 cu. ft.	20	24	7½	160	A 3066 B 3260 C 3491 D 3644 E 4029 F 4415
	L224201-0100-****1A0 Arcadia, Lobby Chair Upholstered, eased edges, Cal 117 foam, oak, natural finish	22½W 26¾D 33½H 13 cu. ft.	21½	25	1½	25	A 781 B 819 C 865 D 895 E 971 F 1046
	L140121-A100-****1A0 Synergy, Lounge Chair, Leg Base Wood rail back, bull nosed edge, Key-Loc® reversible cushions, Cal 117 foam, oak, natural finish	27W 33D 30½H 17.4 cu. ft.	16½	22½	2	60	A 1105 B 1154 C 1213 D 1252 E 1349 F 1447

An underlined character indicates there is a choice available. See page 29-30 for selections and pricing. **** means that a fabric selection is required. List price for C.O.M. material is the same as Grade B. Cartoning charges: Add \$74 to list price per each cartoned lounge chair; Add \$92 to list price per each cartoned loveseat; Add \$116 to list price per each cartoned sofa; Add 10% to list price per any other cartoned lounge seating item.

Full Sized Wood Frame Lounge Seating

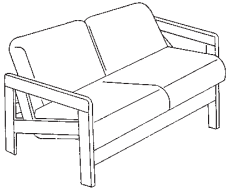
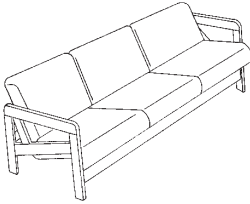
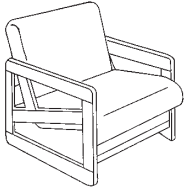
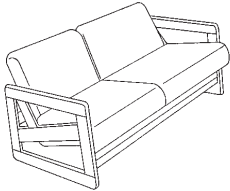
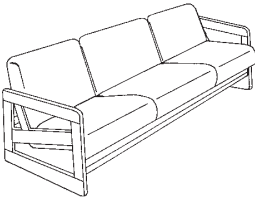
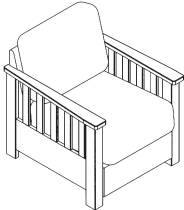
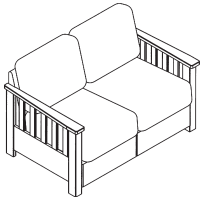

	Model/Description	Dimensions	SH	AH	Ydg.	Wt	List Price
	L140122-A100-****1A0 Synergy, Loveseat, Leg Base Wood rail back, bull nosed edge, Key-Loc® reversible cushions, Cal 117 foam, oak, natural finish	51½W 33D 30½H 32.6 cu. ft.	16½	22½	4	95	A 1966 B 2068 C 2192 D 2274 E 2478 F 2684
	L140123-A100-****1A0 Synergy, Sofa, Leg Base Wood rail back, bull nosed edge, Key-Loc® reversible cushions, Cal 117 foam, oak, natural finish	76W 33D 30½H 47.7 cu. ft.	16½	22½	6	135	A 2713 B 2866 C 3051 D 3175 E 3482 F 3790
	L141121-A100-****1A0 Synergy, Lounge Chair, Sled Base Wood rail back, bull nosed edge, Key-Loc® reversible cushions, Cal 117 foam, oak, natural finish	27W 33D 30½H 17.4 cu. ft.	16½	22	2	65	A 1233 B 1285 C 1347 D 1386 E 1489 F 1592
	L141122-A100-****1A0 Synergy, Loveseat, Sled Base Wood rail back, bull nosed edge, Key-Loc® reversible cushions, Cal 117 foam, oak, natural finish	51½W 33D 30½H 32.6 cu. ft.	16½	22	4	105	A 2022 B 2125 C 2247 D 2329 E 2535 F 2740
	L141123-A100-****1A0 Synergy, Sofa, Sled Base Wood rail back, bull nosed edge, Key-Loc® reversible cushions, Cal 117 foam, oak, natural finish	76W 33D 30½H 47.7 cu. ft.	16½	22	6	145	A 2782 B 2936 C 3121 D 3244 E 3553 F 3860
	L150201-K100-****1A0 Tucson, Lounge Chair Loose reversible cushions, modular, Cal 117 foam, oak, natural finish	28¾W 32¼D 31½H 18.7 cu. ft. Not available in vinyl, or with moisture resistant liners; available with semi-attached cushions. See page 29 & 30 for option pricing.	17½	24	3	60	A 1235 B 1312 C 1401 D 1462 E 1613 F 1765
	L150202-K100-****1A0 Tucson, Loveseat Loose reversible cushions, modular, Cal 117 foam, oak, natural finish	50¾W 32¼D 31½H 32.4 cu. ft. Not available in vinyl, or with moisture resistant liners; available with semi-attached cushions. See page 29 & 30 for option pricing.	17½	24	6	90	A 2029 B 2180 C 2361 D 2482 E 2785 F 3086

An underlined character indicates there is a choice available. See page 29-30 for selections and pricing. **** means that a fabric selection is required. List price for C.O.M. material is the same as Grade B. Cartoning charges: Add \$74 to list price per each cartoned lounge chair; Add \$92 to list price per each cartoned loveseat; Add \$116 to list price per each cartoned sofa; Add 10% to list price per any other cartoned lounge seating item.

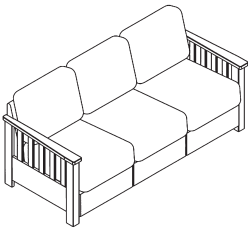
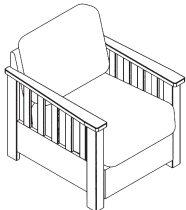
Full Sized Wood Frame Lounge Seating

	Model/Description	Dimensions	SH	AH	Ydg.	Wt	List Price
	L150203-K100-****1A0 Tucson, Sofa Loose and reversible cushions, modular, Cal 117 foam, oak, natural finish	72 ³ / ₄ W 32 ¹ / ₄ D 31H 46.2 cu. ft.	17 ¹ / ₂	24	9	125	A 2792 B 3018 C 3291 D 3472 E 3925 F 4378
		Not available in vinyl, or with moisture resistant liners; available with semi-attached cushions. See page 29 for option pricing.					
	L150211-K100-****1A0 Tucson, Lounge Chair w/ Glider Loose and reversible cushions, modular, Cal 117 foam, oak, natural finish	28 ³ / ₄ W 32 ¹ / ₄ D 31 ¹ / ₂ H 18.7 cu. ft.	17 ¹ / ₂	24	3	60	A 1563 B 1638 C 1729 D 1790 E 1941 F 2091
		Not available in vinyl, or with moisture resistant liners; available with semi-attached cushions. See page 29 for option pricing.					

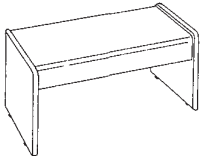
Bench Seating

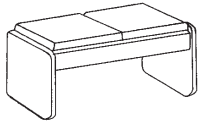
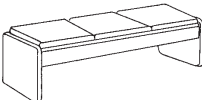
	L300102-0000-00001A0 Endurance, All wood 2-seat bench Butcher block ends, bull nosed edge, oak veneer deck, oak, natural finish	44W 26D 18 ¹ / ₂ H 14.4 cu. ft.				65	846
	L300103-0000-00001A0 Endurance, All wood 3-seat bench Butcher block ends, bull nosed edge, oak veneer deck, oak, natural finish	64 ¹ / ₂ W 26D 18 ¹ / ₂ H 21.0 cu. ft.				80	937
	L310102-0100-****1A0 Endurance, 2-seat bench Butcher block ends, bull nosed edge, Cal 117 foam, oak, natural finish	44W 26D 19 ¹ / ₂ H 14.4 cu. ft.	19 ¹ / ₂		1 ¹ / ₂	65	A 1138 B 1175 C 1223 D 1253 E 1330 F 1406
	L310103-0100-****1A0 Endurance, 3-seat bench Butcher block ends, bull nosed edge, Cal 117 foam, oak, natural finish	64 ¹ / ₂ W 26D 19 ¹ / ₂ H 21.0 cu. ft.	19 ¹ / ₂		2	80	A 1412 B 1463 C 1525 D 1565 E 1668 F 1771

An underlined character indicates there is a choice available. See page 29-30 for selections and pricing. **** means that a fabric selection is required. List price for C.O.M. material is the same as Grade B. Cartoning charges: Add \$74 to list price per each cartoned lounge chair; Add \$92 to list price per each cartoned loveseat; Add \$116 to list price per each cartoned sofa; Add 10% to list price per any other cartoned lounge seating item.

Bench Seating

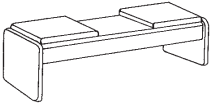
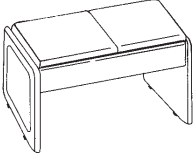
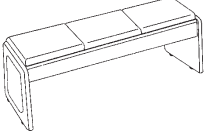
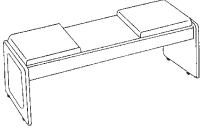
	Model/Description	Dimensions	SH	AH	Ydg.	Wt	List Price
	L310109-0100-****1A0 Endurance, 2-seat bench with table Butcher block ends, bull nosed edge, oak veneer center table insert, Cal 117 foam, oak, natural finish	64½W 26D 19½H 21.0 cu. ft.	19½		1½	80	A 1333 B 1372 C 1418 D 1468 E 1526 F 1603
		Table insert will match wood finish.					
	L311102-0100-****1A0 Endurance, Traditional 2-seat bench Butcher block ends, bull nosed edge, Cal 117 foam, oak, natural finish	44W 26D 19½H 14.4 cu. ft.	19½		1½	65	A 1242 B 1279 C 1327 D 1357 E 1434 F 1510
	L311103-0100-****1A0 Endurance, Traditional 3-seat bench Butcher block ends, bull nosed edge, Cal 117 foam, oak, natural finish	64½W 26D 19½H 21.0 cu. ft.	19½		2	80	A 1509 B 1561 C 1623 D 1664 E 1767 F 1868
	L311109-0100-****1A0 Endurance, Traditional 2-seat bench with table Butcher block ends, bull nosed edge, oak veneer center table insert, Cal 117 foam, oak, natural finish	64½W 26D 19½H 21.0 cu. ft.	19½		1½	80	A 1435 B 1474 C 1520 D 1550 E 1627 F 1705
		Table insert will match wood finish.					

Living Room Seating

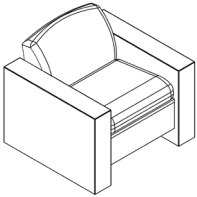
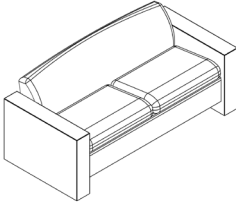
	L400001-0100-****000 Eros Chair Square Arm Fully upholstered, loose reversible seat cushion, tight back cushion, Cal 117 foam	34W 32.5D 31H 21.7 cu. ft.	18	23	5	65	A 1214 B 1339 C 1491 D 1592 E 1843 F 2096
		*Not available in vinyl or with moisture resistant liners *All fabric will be Railroaded					
	L400003-0100-****000 Eros Sofa Square Arm Fully upholstered, loose reversible seat cushion, tight back cushion, Cal 117 foam	70W 32.5D 31H 44.1 cu. ft.	18	23	8	105	A 2176 B 2377 C 2619 D 2779 E 3182 F 3585
		*Not available in vinyl or with moisture resistant liners *All fabric will be Railroaded * When not cut railroad, seam will run down the front and back of the back cushion and extra fabric yardage will be required.					

An underlined character indicates there is a choice available. See page 29-30 for selections and pricing. **** means that a fabric selection is required. List price for C.O.M. material is the same as Grade B. Cartoning charges: Add \$74 to list price per each cartoned lounge chair; Add \$92 to list price per each cartoned loveseat; Add \$116 to list price per each cartoned sofa; Add 10% to list price per any other cartoned lounge seating item.

Field Description:	Class Type	Product Line	Edge	Back Panel	# of Seats	Cushion Type	Foam Options	Options/Accessories	Fabric Grade	Fabric Pattern	Wood Type	Finish	Special							
Field Position:	1	2	3	4	5	6	7	8	9	10	11	12	13	14	15	16	17	18	19	20
	L	4	0	0	0	-	0	0	0	0	0	0	-	X	0	0	0	0	X	0

Living Room Seating

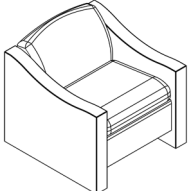
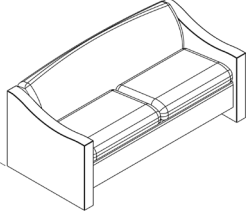
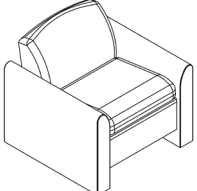
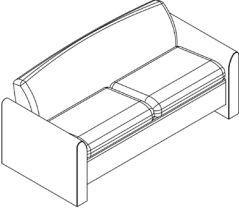
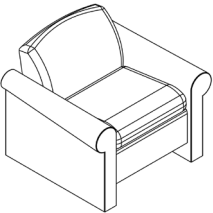
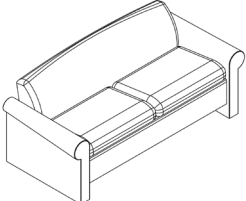
	Model/Description	Dimensions	SH	AH	Ydg.	Wt	List Price
	L401001-0100-****000 Sabre Chair Sloped Arm Fully upholstered, loose reversible seat cushion, tight back cushion, Cal 117 foam	31W 32½D 31H 19.9 cu. ft.	18	28	6¼	55	A 983 B 1159 C 1370 D 1512 E 1864 F 2217
							*Not available in vinyl or with moisture resistant liners *All fabric will be Railroaded
	L401003-0100-****000 Sabre Sofa Sloped Arm Fully upholstered, loose reversible seat cushion, tight back cushion, Cal 117 foam	67W 32½D 31H 42.2 cu. ft.	18	28	9½	95	A 1628 B 1880 C 2182 D 2384 E 2888 F 3391
							*Not available in vinyl or with moisture resistant liners *All fabric will be Railroaded * When not cut railroad, seam will run down the front and back of the back cushion and extra fabric yardage will be required.
	L403001-0100-****000 Tarvos Chair Winged Arm Fully upholstered, loose reversible seat cushion, tight back cushion, Cal 117 foam	33W 32½D 31H 21.1 cu. ft.	18	23	5	65	A 1236 B 1363 C 1514 D 1615 E 1867 F 2118
							*Not available in vinyl or with moisture resistant liners *All fabric will be Railroaded
	L403003-0100-****000 Tarvos Sofa Winged Arm Fully upholstered, loose reversible seat cushion, tight back cushion, Cal 117 foam	69W 32½D 31H 43.4 cu. ft.	18	23	8	105	A 2199 B 2399 C 2641 D 2802 E 3206 F 3609
							*Not available in vinyl or with moisture resistant liners *All fabric will be Railroaded * When not cut railroad, seam will run down the front and back of the back cushion and extra fabric yardage will be required.
	L404001-0100-****000 Sabre Chair Rolled Arm Fully upholstered, loose reversible seat cushion, tight back cushion, Cal 117 foam	36W 32½D 31H 23 cu. ft.	18	23½	5¾	65	A 1041 B 1192 C 1373 D 1494 E 1797 F 2099
							*Not available in vinyl or with moisture resistant liners *All fabric will be Railroaded
	L404003-0100-****000 Sabre Sofa Rolled Arm Fully upholstered, loose reversible seat cushion, tight back cushion, Cal 117 foam	72W 32½D 31H 45.3 cu. ft.	18	23½	9	105	A 1693 B 1919 C 2191 D 2373 E 2826 F 3279
							*Not available in vinyl or with moisture resistant liners *All fabric will be Railroaded * When not cut railroad, seam will run down the front and back of the back cushion and extra fabric yardage will be required.

An underlined character indicates there is a choice available. See page 29-30 for selections and pricing. **** means that a fabric selection is required. List price for C.O.M. material is the same as Grade B. Cartoning charges: Add \$74 to list price per each cartoned lounge chair; Add \$92 to list price per each cartoned loveseat; Add \$116 to list price per each cartoned sofa; Add 10% to list price per any other cartoned lounge seating item.

Living Room Seating

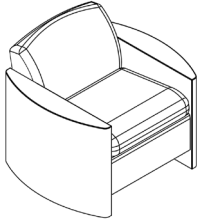
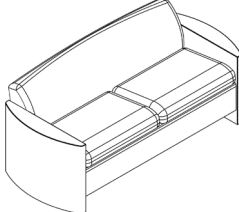
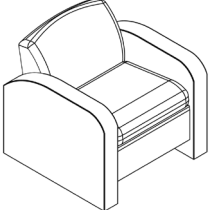
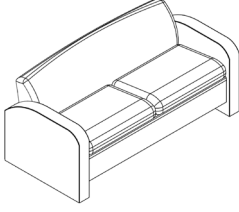
	Model/Description	Dimensions	SH	AH	Ydg.	Wt	List Price
	L406001-0100-****000 Estel Chair Half-Moon Arm Fully upholstered, loose reversible seat cushion, tight back cushion, Cal 117 foam	35W 32½D 31H 22.3 cu. ft.	18	23	6	65	A 1236 B 1388 C 1569 D 1690 E 1993 F 2294
							*Not available in vinyl or with moisture resistant liners *All fabric will be Railroaded
	L406003-0100-****000 Estel Sofa Half-Moon Arm Fully upholstered, loose reversible seat cushion, tight back cushion, Cal 117 foam	71W 32½D 31H 44.7 cu. ft.	18	23	9	105	A 2199 B 2425 C 2697 D 2878 E 3332 F 3785
							*Not available in vinyl or with moisture resistant liners *All fabric will be Railroaded * When not cut railroad, seam will run down the front and back of the back cushion and extra fabric yardage will be required.
	L407001-0100-****000 Bristol Chair Contoured Arm Fully upholstered, loose reversible seat cushion, tight back cushion, Cal 117 foam	33W 32½D 31H 21.1 cu. ft.	18	25	7	65	A 1236 B 1414 C 1625 D 1766 E 2118 F 2470
							*Not available in vinyl or with moisture resistant liners *All fabric will be Railroaded
	L407003-0100-****000 Bristol Sofa Contoured Arm Fully upholstered, loose reversible seat cushion, tight back cushion, Cal 117 foam	69W 32½D 31H 43.4 cu. ft.	18	25	10	105	A 2199 B 2450 C 2753 D 2954 E 3457 F 3961
							*Not available in vinyl or with moisture resistant liners *All fabric will be Railroaded * When not cut railroad, seam will run down the front and back of the back cushion and extra fabric yardage will be required.

Fully Upholstered Lounge Seating

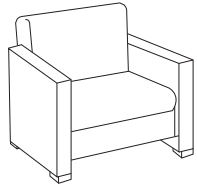
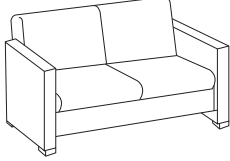
	L420041-A100-****1A0 Ambassador Lounge Chair Fully upholstered, Key-Loc® reversible cushions, Cal 117 foam, oak feet, natural finish	31W 33D 31H 20.2 cu. ft.	17½	24½	6	90	A 1606 B 1758 C 1941 D 2064 E 2369 F 2673
	L420042-A100-****1A0 Ambassador Loveseat Fully upholstered, Key-Loc® reversible cushions, Cal 117 foam, oak feet, natural finish	56W 33D 31H 35.9 cu. ft.	17½	24½	8	135	A 2419 B 2630 C 2883 D 3053 E 3475 F 3897

An underlined character indicates there is a choice available. See page 29-30 for selections and pricing. **** means that a fabric selection is required. List price for C.O.M. material is the same as Grade B. Cartoning charges: Add \$74 to list price per each cartoned lounge chair; Add \$92 to list price per each cartoned loveseat; Add \$116 to list price per each cartoned sofa; Add 10% to list price per any other cartoned lounge seating item.

Fully Upholstered Lounge Seating

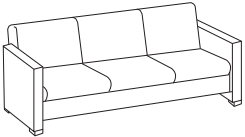
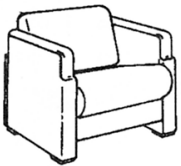
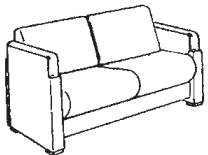
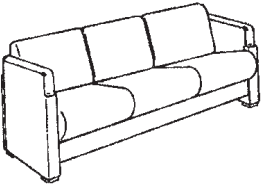
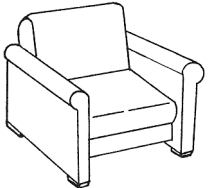
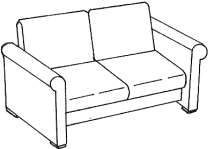
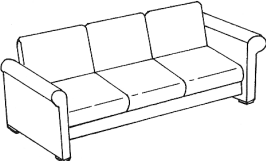
	Model/Description	Dimensions	SH	AH	Ydg.	Wt	List Price
	L420043-A100-****1A0 Ambassador Sofa Fully upholstered, Key-Loc® reversible cushions, Cal 117 foam, oak feet, natural finish	80W 33D 31H 51 cu. ft.	17½	24½	11	180	A 3164 B 3454 C 3802 D 4035 E 4616 F 5197
	L422041-A100-****1A0 Ambassador Lounge Chair, w/Bentply Arm Caps Fully upholstered, Key-Loc® reversible cushions, Cal 117 foam, oak arm caps and feet, natural finish	31W 33D 31H 20.2 cu. ft.	17½	24½	6	100	A 2090 B 2242 C 2423 D 2544 E 2846 F 3148
	L422042-A100-****1A0 Ambassador Loveseat, w/Bentply Arm Caps Fully upholstered, Key-Loc® reversible cushions, Cal 117 foam, oak arm caps and feet, natural finish	56W 33D 31H 35.9 cu. ft.	17½	24½	8	145	A 2927 B 3133 C 3378 D 3543 E 3954 F 4364
	L422043-A100-****1A0 Ambassador Sofa, w/Bentply Arm Caps Fully upholstered, Key-Loc® reversible cushions, Cal 117 foam, oak arm caps and feet, natural finish	80W 33D 31H 51 cu. ft.	17½	24½	11	190	A 3665 B 3947 C 4287 D 4512 E 5077 F 5642
	L424041-A100-****1A0 Ambassador Lounge Chair, w/Rolled Arms Fully upholstered, Key-Loc® reversible cushions, Cal 117 foam, oak feet, natural finish	36W 33D 31H 23.3 cu. ft.	17½	24½	6½	90	A 1756 B 1922 C 2124 D 2256 E 2590 F 2924
	L424042-A100-****1A0 Ambassador Loveseat, w/Rolled Arms Fully upholstered, Key-Loc® reversible cushions, Cal 117 foam, oak feet, natural finish	61W 33D 31H 39.1 cu. ft.	17½	24½	9	135	A 2543 B 2778 C 3061 D 3249 E 3720 F 4191
	L424043-A100-****1A0 Ambassador, Sofa, w/Rolled Arms Fully upholstered, Key-Loc® reversible cushions, Cal 117 foam, oak feet, natural finish	85W 33D 31H 54.2 cu. ft.	17½	24½	11½	180	A 3307 B 3609 C 3969 D 4210 E 4811 F 5413

An underlined character indicates there is a choice available. See page 29-30 for selections and pricing. **** means that a fabric selection is required. List price for C.O.M. material is the same as Grade B. Cartoning charges: Add \$74 to list price per each cartoned lounge chair; Add \$92 to list price per each cartoned loveseat; Add \$116 to list price per each cartoned sofa; Add 10% to list price per any other cartoned lounge seating item.

Fully Upholstered Lounge Seating

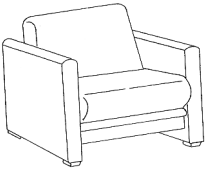
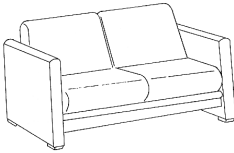
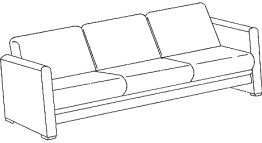
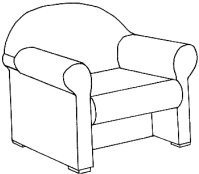
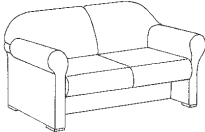
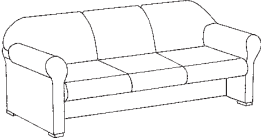
	Model/Description	Dimensions	SH	AH	Ydg.	Wt	List Price
	L425041-A100-****1A0 Aries Lounge Chair Fully upholstered, Key-Loc® reversible cushions, Cal 117 foam, oak feet, natural finish	31W 33D 31H 20.2 cu. ft.	17½	24½	6	90	A 1914 B 2066 C 2246 D 2367 E 2670 F 2972
	L425042-A100-****1A0 Aries Loveseat Fully upholstered, Key-Loc® reversible cushions, Cal 117 foam, oak feet, natural finish	56W 33D 31H 35.9 cu. ft.	17½	24½	9	135	A 2691 B 2922 C 3199 D 3384 E 3846 F 4308
	L425043-A100-****1A0 Aries Sofa Fully upholstered, Key-Loc® reversible cushions, Cal 117 foam, oak feet, natural finish	80W 33D 31H 51 cu. ft.	17½	24½	11½	180	A 3574 B 3876 C 4237 D 4477 E 5079 F 5680
	L430041-0100-****1A0 Regent Lounge Chair Fully upholstered, Key-Loc® reversible seat cushion, removable back cushion, Cal 117 foam, oak feet, natural finish	38W 34D 34H 27.7 cu. ft. Not available in vinyl.	17½	25	9	100	A 1974 B 2211 C 2497 D 2686 E 3162 F 3637
	L430042-0100-****1A0 Regent Loveseat Fully upholstered, Key-Loc® reversible seat cushion, removable back cushion, Cal 117 foam, oak feet, natural finish	63W 34D 34H 45.4 cu. ft. Not available in vinyl.	17½	25	12	145	A 2958 B 3275 C 3655 D 3908 E 4542 F 5176
	L430043-0100-****1A0 Regent Sofa Fully upholstered, Key-Loc® reversible seat cushion, removable back cushion, Cal 117 foam, oak feet, natural finish	87W 34D 34H 62.4 cu. ft. Not available in vinyl.	17½	25	16	190	A 3913 B 4336 C 4842 D 5180 E 6025 F 6869

An underlined character indicates there is a choice available. See page 29-30 for selections and pricing. **** means that a fabric selection is required. List price for C.O.M. material is the same as Grade B. Cartoning charges: Add \$74 to list price per each cartoned lounge chair; Add \$92 to list price per each cartoned loveseat; Add \$116 to list price per each cartoned sofa; Add 10% to list price per any other cartoned lounge seating item.

Living Room Seating

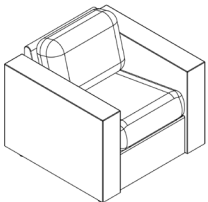
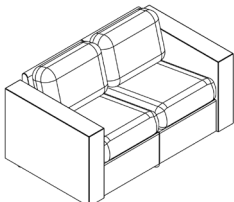
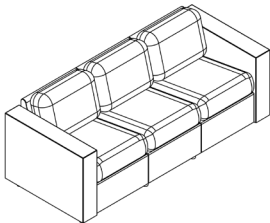
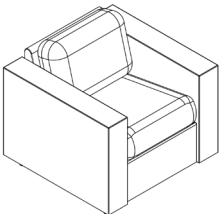
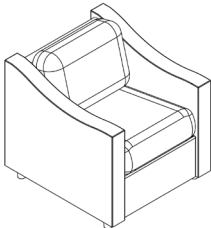
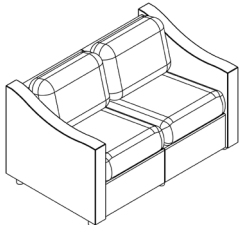
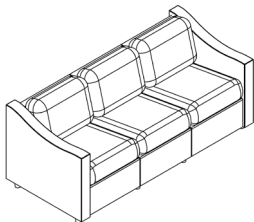
	Model/Description	Dimensions	SH	AH	Ydg.	Wt	List Price
	L450001-K100-****000 Casual Comfort Lounge Chair Square Arm Fully upholstered, loose and reversible cushion styling, Cal 117 foam, modular	32W 32D 30H 19.6 cu. ft.	17	25	6	80	A 1291 B 1445 C 1630 D 1753 E 2062 F 2369
	L450002-K100-****000 Casual Comfort Loveseat Square Arm Fully upholstered, loose and reversible cushion styling, Cal 117 foam, modular	54W 32D 30H 32.6 cu. ft.	17	25	9	115	A 2069 B 2300 C 2578 D 2762 E 3224 F 3686
	L450003-K100-****000 Casual Comfort Sofa Square Arm Fully upholstered, loose and reversible cushion styling, Cal 117 foam, modular	76W 32D 30H 45.6 cu. ft.	17	25	12	150	A 2848 B 3156 C 3525 D 3772 E 4387 F 5004
	L450011-K100-****000 Casual Comfort Lounge Chair w/glider Square Arm Fully upholstered, loose and reversible cushion styling, Cal 117 foam	32W 32D 30H 19.6 cu. ft.	17	25	6	80	A 1625 B 1779 C 1963 D 2087 E 2394 F 2703
	L451001-K100-****000 Malibu Chair Sloped Arm Fully upholstered, loose and reversible cushion styling, Cal 117 foam, modular	29W 32D 30H 17.8 cu. ft.	17	30	7	70	A 1328 B 1504 C 1716 D 1858 E 2210 F 2562
	L451002-K100-****000 Malibu Loveseat Sloped Arm Fully upholstered, loose and reversible cushion styling, Cal 117 foam, modular	51W 32D 30H 30.8 cu. ft.	17	30	10	105	A 2060 B 2313 C 2615 D 2817 E 3320 F 3824
	L451003-K100-****000 Malibu Sofa Sloped Arm Fully upholstered, loose and reversible cushion styling, Cal 117 foam, modular	73W 32D 30H 43.8 cu. ft.	17	30	12	140	A 2794 B 3096 C 3458 D 3700 E 4304 F 4908

An underlined character indicates there is a choice available. See page 29-30 for selections and pricing. **** means that a fabric selection is required. List price for C.O.M. material is the same as Grade B. Cartoning charges: Add \$74 to list price per each cartoned lounge chair; Add \$92 to list price per each cartoned loveseat; Add \$116 to list price per each cartoned sofa; Add 10% to list price per any other cartoned lounge seating item.

Living Room Seating

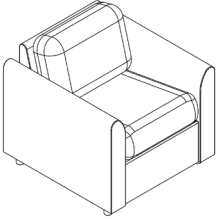
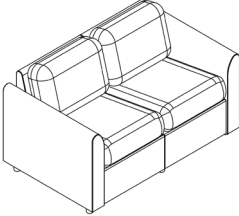
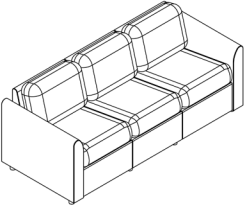
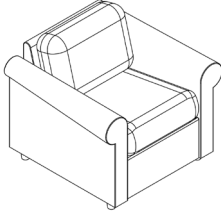
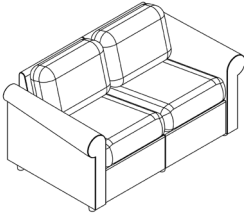
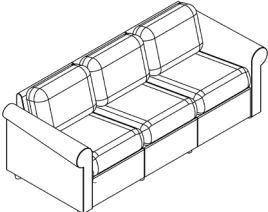
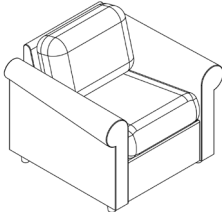
	Model/Description	Dimensions	SH	AH	Ydg.	Wt	List Price
	L453001-K100-****000 Aurora Chair Winged Arm Fully upholstered, loose and reversible cushion styling, Cal 117 foam, modular	31W 32D 30H 18.9 cu. ft.	17	25	6	80	A 1354 B 1508 C 1693 D 1816 E 2125 F 2432
	L453002-K100-****000 Aurora Loveseat Winged Arm Fully upholstered, loose and reversible cushion styling, Cal 117 foam, modular	53W 32D 30H 32 cu. ft.	17	25	9	115	A 2100 B 2331 C 2610 D 2793 E 3255 F 3717
	L453003-K100-****000 Aurora Sofa Winged Arm Fully upholstered, loose and reversible cushion styling, Cal 117 foam, modular	75W 32D 30H 45 cu. ft.	17	25	12	150	A 2848 B 3156 C 3525 D 3772 E 4387 F 5004
	L454001-K100-****000 Casual Comfort Lounge Chair Rolled Arm Fully upholstered, loose and reversible cushion styling, Cal 117 foam, modular	34W 32D 30H 20.7 cu. ft.	17	25½	6	80	A 1427 B 1578 C 1759 D 1880 E 2182 F 2485
	L454002-K100-****000 Casual Comfort Loveseat Rolled Arm Fully upholstered, loose and reversible cushion styling, Cal 117 foam, modular	56W 32D 30H 33.7 cu. ft.	17	25½	9	115	A 2306 B 2537 C 2814 D 2999 E 3461 F 3923
	L454003-K100-****000 Casual Comfort Sofa Rolled Arm Fully upholstered, loose and reversible cushion styling, Cal 117 foam, modular	78W 32D 30H 46.8 cu. ft.	17	25½	12	150	A 3007 B 3314 C 3684 D 3931 E 4546 F 5162
	L454011-K100-****000 Casual Comfort Lounge Chair w/ Glider Rolled Arm Fully upholstered, loose and reversible cushion styling, Cal 117 foam	34W 32D 30H 20.7 cu. ft.	17	25½	6	80	A 1791 B 1942 C 2122 D 2244 E 2547 F 2848

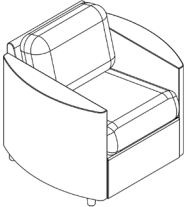
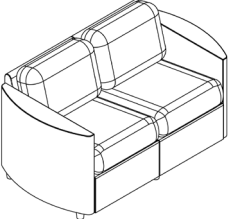
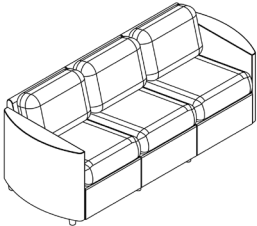
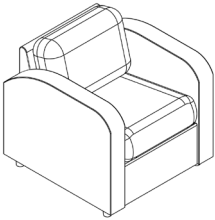
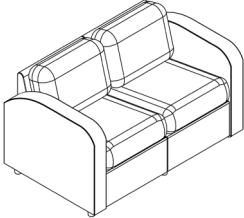
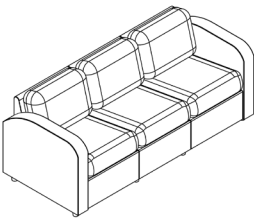

An underlined character indicates there is a choice available. See page 29-30 for selections and pricing. **** means that a fabric selection is required. List price for C.O.M. material is the same as Grade B. Cartoning charges: Add \$74 to list price per each cartoned lounge chair; Add \$92 to list price per each cartoned loveseat; Add \$116 to list price per each cartoned sofa; Add 10% to list price per any other cartoned lounge seating item.

Living Room Seating

	Model/Description	Dimensions	SH	AH	Ydg.	Wt	List Price
	L456001-K100-****000 Haley Chair Half-Moon Arm Fully upholstered, loose and reversible cushion styling, Cal 117 foam, modular	33W 32D 30H 20.1 cu. ft.	17	25	7	80	A 1367 B 1548 C 1766 D 1912 E 2274 F 2637
		Not available in vinyl, or with moisture resistant liners; available with semi-attached cushions. See page 29 for option pricing.					
	L456002-K100-****000 Haley Loveseat Half-Moon Arm Fully upholstered, loose and reversible cushion styling, Cal 117 foam, modular	55W 32D 30H 33.2 cu. ft.	17	25	10	115	A 2160 B 2425 C 2742 D 2953 E 3481 F 4009
		Not available in vinyl, or with moisture resistant liners; available with semi-attached cushions. See page 29 for option pricing.					
	L456003-K100-****000 Haley Sofa Half-Moon Arm Fully upholstered, loose and reversible cushion styling, Cal 117 foam, modular	77W 32D 30H 46.2 cu. ft.	17	25	12	150	A 2848 B 3156 C 3525 D 3772 E 4387 F 5004
		Not available in vinyl, or with moisture resistant liners; available with semi-attached cushions. See page 29 for option pricing.					
	L457001-K100-****000 Pomona Chair Contoured Arm Fully upholstered, loose and reversible cushion styling, Cal 117 foam, modular	31W 32D 30H 18.9 cu. ft.	17	27	7	80	A 1367 B 1548 C 1766 D 1912 E 2274 F 2637
		Not available in vinyl, or with moisture resistant liners; available with semi-attached cushions. See page 29 for option pricing.					
	L457002-K100-****000 Pomona Loveseat Contoured Arm Fully upholstered, loose and reversible cushion styling, Cal 117 foam, modular	53W 32D 30H 32 cu. ft.	17	27	9	115	A 2160 B 2398 C 2684 D 2873 E 3348 F 3824
		Not available in vinyl, or with moisture resistant liners; available with semi-attached cushions. See page 29 for option pricing.					
	L457003-K100-****000 Pomona Sofa Contoured Arm Fully upholstered, loose and reversible cushion styling, Cal 117 foam, modular	75W 32D 30H 45 cu. ft.	17	27	12	150	A 2848 B 3156 C 3525 D 3772 E 4387 F 5004
		Not available in vinyl, or with moisture resistant liners; available with semi-attached cushions. See page 29 for option pricing.					

An underlined character indicates there is a choice available. See page 29-30 for selections and pricing. **** means that a fabric selection is required. List price for C.O.M. material is the same as Grade B. Cartoning charges: Add \$74 to list price per each cartoned lounge chair; Add \$92 to list price per each cartoned loveseat; Add \$116 to list price per each cartoned sofa; Add 10% to list price per any other cartoned lounge seating item.

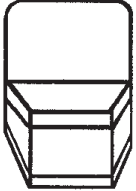
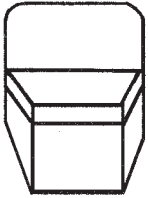
Modular Lounge Seating

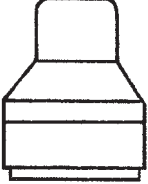
	Model/Description	Dimensions	SH	AH	Ydg.	Wt	List Price
	L630011-0100-****000 Paragon 90° Straight Unit Upholstered base, Cal 117 foam, black plinth	24W 30D 30H 13.9 cu. ft.	18		3	50	A 1046 B 1119 C 1207 D 1266 E 1413 F 1559
		Not available with Cal 133 fire retardant foam or moisture resistant lining.					
	L631011-0100-****000 Paragon 22.5° Wedge Unit Wide back, upholstered base, Cal 117 foam, black plinth	27W 30D 30H 15.6 cu. ft.	18		3	50	A 1116 B 1189 C 1277 D 1336 E 1483 F 1629
		Not available with Cal 133 fire retardant foam or moisture resistant lining.					
	L632011-0100-****000 Paragon 30° Wedge Unit Wide back, upholstered base, Cal 117 foam, black plinth	30½W 30D 30H 17.6 cu. ft.	18		¾	55	A 1159 B 1233 C 1320 D 1379 E 1526 F 1673
		Not available with Cal 133 fire retardant foam or moisture resistant lining.					
	L633011-0100-****000 Paragon 22.5° Wedge Unit Narrow back, upholstered base, Cal 117 foam, black plinth	27W 30D 30H 15.6 cu. ft.	18		3	45	A 1144 B 1217 C 1305 D 1364 E 1510 F 1657
		Not available with Cal 133 fire retardant foam or moisture resistant lining.					
	L634011-0100-****000 Paragon 30° Wedge Unit Narrow back, upholstered base, Cal 117 foam, black plinth	30½W 30D 30H 17.6 cu. ft.	18		3	50	A 1127 B 1200 C 1288 D 1347 E 1494 F 1640
		Not available with Cal 133 fire retardant foam or moisture resistant lining.					

An underlined character indicates there is a choice available. See page 29-30 for selections and pricing. **** means that a fabric selection is required. List price for C.O.M. material is the same as Grade B. Cartoning charges: Add \$74 to list price per each cartoned lounge chair; Add \$92 to list price per each cartoned loveseat; Add \$116 to list price per each cartoned sofa; Add 10% to list price per any other cartoned lounge seating item.

Field Description:	Class Type	Product Line	Edge	Back Panel	# of Seats	Cushion Type	Foam Options	Options/Accessories	Fabric Grade	Fabric Pattern	Wood Type	Finish	Special							
Field Position:	1	2	3	4	5	6	7	8	9	10	11	12	13	14	15	16	17	18	19	20
	L9	00	0	0	0	-	X	0	00	-	X	000	0	X	0					

Specialty Seating

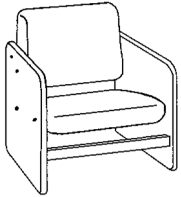
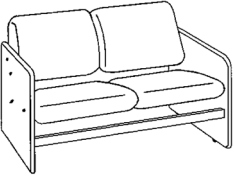
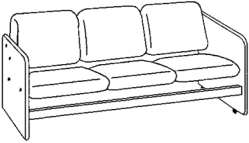
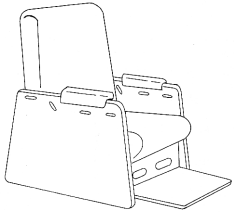
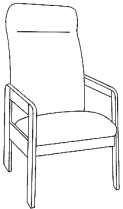
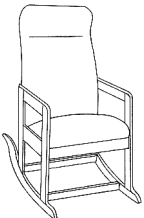
	Model/Description	Dimensions	SH	AH	Ydg.	Wt	List Price
	L280101-0000-R***1A0 Integrity Lounge Chair Butcher block ends, 200 mil reversible Roto-Mold cushions, flow-thru gap, bull nosed edge, oak, natural finish	24½W 29D 30H 13.7 cu. ft.	17	23½		120	2209
	L280102-0000-R***1A0 Integrity Loveseat Chair Butcher block ends, 200 mil reversible Roto-Mold cushions, flow-thru gap, bull nosed edge, oak, natural finish	46W 29D 30H 25.3 cu. ft.	17	23½		185	3725
	L280103-0000-R***1A0 Integrity Sofa Butcher block ends, 200 mil reversible Roto-Mold cushions, flow-thru gap, bull nosed edge, oak, natural finish	67½W 29D 30H 36.9 cu. ft.	17	23½		250	5257
	L910201-0200-****1A0 Safety Support Chair w/Footrest Wide based butcher block end panels with restraint slots and upholstered arm pads, eased edge, footrest, KeyLoc® reversible cushions, Cal 117 foam, moisture resistant seat, oak, natural finish	31W 42½D 45H (w/footrest extended: 58D) 37.1 cu. ft.	17	25	3	180	A 3216 B 3292 C 3385 D 3447 E 3600 F 3754
	L920101-0100-****1A0 Silhouette Chair Leg base, bull nosed edge, ergonomic high back cushion, Cal 117 foam, oak, natural finish	24W 27D 44½H 18.5 cu. ft.	18	24	2½	45	A 1253 B 1314 C 1387 D 1436 E 1558 F 1680
	L924101-0100-****1A0 Silhouette Rocker Bull nosed edge, ergonomic high back cushion, Cal 117 foam, oak, natural finish	24W 38½D 44H 25.8 cu. ft.	19	24½	2½	50	A 1435 B 1496 C 1569 D 1618 E 1740 F 1863

An underlined character indicates there is a choice available. See page 29-30 for selections and pricing. **** means that a fabric selection is required. List price for C.O.M. material is the same as Grade B. Cartoning charges: Add \$74 to list price per each cartoned lounge chair; Add \$92 to list price per each cartoned loveseat; Add \$116 to list price per each cartoned sofa; Add 10% to list price per any other cartoned lounge seating item.

Field Description:		Class Shape	Top Size	Top Type	Base	Metal Finish	Options/ Accessories					N/A	N/A	Wood Type	Finish	Special					
Field Position:		1	2	3	4	5	6	7	8	9	10	11	12	13	14	15	16	17	18	19	20
		T0	0	0	00	0	-	0000	-	0	000	0	X	0							

Dining, Study, Activity Table Tops

#3 & 4 top types: laminate will match base finish unless otherwise specified. If base is metal, the laminate will match natural oak finish unless otherwise specified.

#3 top type: Standard natural oak laminate tops will have matching PVC edge; all other finishes will receive a BLACK PVC edge.

Top Type		
3	4	5
Laminate Top, PVC Edge 1¼" thick, plastic, laminate top, 3mm PVC edge 5½ lb/sq. ft.	Laminate Top, Wood Edge 1¼" thick, plastic, laminate top, ½" wide solid oak edge, bull nosed 5¼ lb/sq. ft.	Butcher Block Top 1¾" thick solid red oak, bull nosed edge, radius corners 6¼ lb/sq. ft.

F.O.B. Origin

Table Shape		Top Size		List Price			
Sel	Description	Sel	Description	#3 Above	#4 Above	#5 Above	Cube
1	Round Tables: <i>Applies to the following bases:</i> 22, 24, 30, 31, 35, 90, 91, 92, 95, 96 +48" not available with 22, 24 & 35 bases	1	30" diameter	327	N/A	747	1.2
		2	36" diameter	464	N/A	1068	1.6
		3	42" diameter	629	N/A	1416	2.2
		+4	48" diameter	813	N/A	1781	2.8
2	Square Tables: <i>Applies to the following bases:</i> 22, 24, 30, 31, 35, 85, 90, 91, 92, 95, 96 +48" not available with 22, 24 & 35 bases	1	30" x 30"	327	449	727	1.2
		2	36" x 36"	464	582	1040	1.6
		3	42" x 42"	629	749	1388	2.2
		+4	48" x 48"	813	1067	1756	2.8
3	Rectangular Tables: <i>Applies to the following bases:</i> 50, 51, 85, 90, 91, 92, 95, 96 +36" x 72" not available with 90, 91, 92, 95 and 96 bases	1	30" x 48"	524	635	1173	1.8
		2	30" x 60"	654	757	1424	2.2
		3	36" x 60"	785	891	1665	2.7
		+4	36" x 72"	940	1101	1974	3.2

NOTE: When ordering tables, the first three digits specify the top while the next three digits select the base. Add list price of top to list price of base for total list price of table. Options or extra features will be additional.

Table tops & bases shipped unassembled (KD). Cartoning charges: Add \$53 to list price for each cartoned table.

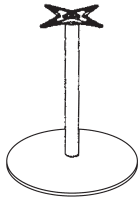
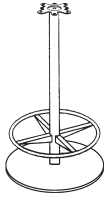
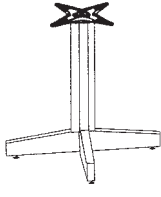
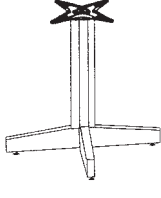
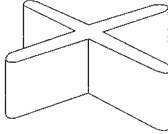

Field Description:	Class Shape	Top Size	Top Type	Base	Metal Finish	Options/ Accessories	N/A	N/A	Wood Type	Finish	Special									
Field Position:	1	2	3	4	5	6	7	8	9	10	11	12	13	14	15	16	17	18	19	20
	T	0	0	00	0			-	0000					0	000	0	X	0		

Dining, Study, Activity Table Bases

	Model/Description	Top Size	Ht	Wt	Cube	List Price
	T***222-0000-0000##0 Pedestal Base (#22) Cast iron base, steel column, black wrinkle finish	30" rd/sq 36" rd/sq 42" rd	29"	35	8.8	319
	T***242-0000-0000##0 Pedestal Base (#24) Bar Height Cast iron base, steel column, black wrinkle finish, black foot ring	30" rd/sq 36" rd/sq	41"	37	12.9	528
	T***300-0000-00001A0 Pedestal Base (#30) Butcher block base 30" spread, oak, natural finish	30" rd/sq 36" rd/sq 42" rd/sq 48" rd/sq	29"	22	9.5	517
	T***310-0000-00001A0 Pedestal Base (#31) Wheelchair Height Butcher block base 30" spread, oak, natural finish	30" rd/sq 36" rd/sq 42" rd/sq 48" rd/sq	32"	24	10.7	556
	T***350-0000-00001A0 X-Panel Base (#35) Butcher block base 28" spread, bull nosed edges, oak, natural finish	30" rd/sq 36" rd/sq 42" rd/sq	15"	29	5.5	488

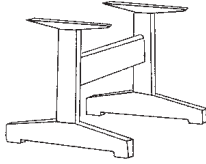
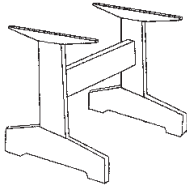
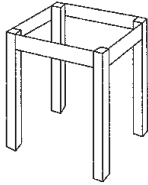
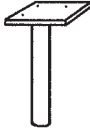

An underlined character indicates there is a choice available. See page 35 for selections and pricing. ** Standard natural oak laminate and PVC edge. All other laminate selections will have black PVC edge. Note: when ordering tables, the first three digits specify the top while the next three digits select the base. Add list price of top to list price of base for total list price of table. Options or extra features will be additional. Table tops & bases shipped un-assembled (KD). Cartoning charges: Add \$53 to list price for each cartoned table.

Dining, Study, Activity Table Bases

	Model/Description	Top Size	Ht	Wt	Cube	List Price
	T***500-0000-00001A0 Trestle Base (#50) Butcher block base, oak, natural finish	30 x 48	29"	33	3.8	612
		30 x 60	29"	33	3.8	612
		36 x 60	29"	33	3.8	612
		36 x 72	29"	35	3.8	639
	T***510-0000-00001A0 Trestle Base (#51) Wheelchair Height Butcher block base, oak, natural finish	30 x 48	32½"	35	4.1	639
		30 x 60	32½"	35	4.1	639
		36 x 60	32½"	35	4.1	639
		36 x 72	32½"	37	4.1	666
	T***850-0000-00001A0 Apron Base (#85) 2¼" square legs, oak, natural finish 26" clearance under apron	36 sq	31	29	21.7	634
		42 sq	31	31	29.7	662
		48 sq	31	34	39.0	662
		30 x 48	31	30	24.1	628
		30 x 60	31	33	30.2	650
		36 x 60	31	34	36.5	673
		36 x 72	31	36	43.9	695
	T***902-0000-0000##0 Table Legs (Base #90) Set of four, round legs, black enamel steel	top sizes over 30" sq or 36" rd	29"	28	2.0	593
	T***910-0000-00001A0 Table Legs (Base #91) Set of four, 2¼" round legs w/ cast iron spiders, oak, natural finish	top sizes over 30" sq or 36" rd	29"	24	2.0	429
	T***920-0000-00001A0 Table Legs (Base #92) Wheelchair Height Set of four, 2¼" round legs w/ cast iron spiders, oak, natural finish	top sizes over 30" sq or 36" rd	32½"	26	2.0	439

An underlined character indicates there is a choice available. See page 35 for selections and pricing. ** Standard natural oak laminate and PVC edge. All other laminate selections will have black PVC edge. Note: when ordering tables, the first three digits specify the top while the next three digits select the base. As list price of top to list price of base for total list price of table. Options or extra features will be additional. Table tops & bases shipped un-assembled (KD). Cartoning charges: Add \$53 to list price for each cartoned table.

Dining, Study, Activity Table Bases

	Model/Description	Top Size	Ht	Wt	Cube	List Price
	T***950-0000-00001A0 Table Legs (Base #95) Set of four, 2¼" square legs w/ cast iron spiders, oak, natural finish	top sizes over 30" sq or 36" rd	29"	28	2.0	400
	T***960-0000-00001A0 Table Legs (Base #96) Wheelchair Height Set of four, 2¼" square legs w/ cast iron spiders, oak, natural finish	top sizes over 30" sq or 36" rd	32½"	30	2.0	423

An underlined character indicates there is a choice available. See page 35 for selections and pricing. ** Standard natural oak laminate and PVC edge. All other laminate selections will have black PVC edge. Note: when ordering tables, the first three digits specify the top while the next three digits select the base. Add list price of top to list price of base for total list price of table. Options or extra features will be additional. Table tops & bases shipped un-assembled (KD). Cartoning charges: Add \$53 to list price for each cartoned table.

Field Description:	Class Shape	Top Size	Top Type	Base	Metal Finish	Options/ Accessories	N/A	N/A	Wood Type	Finish	Special									
Field Position:	1	2	3	4	5	6	7	8	9	10	11	12	13	14	15	16	17	18	19	20
	T0	0	0	00	0	-	0000	-	0	000	0	X	0							

Dining, Study, Activity Tables & Bases

Option Selection & Pricing Guide

Field Description:	Options				Finish			
Field Position:	9, 10, 11, 12				19			
Selection Description:	N/A	Game Top	Plywood Core	Custom Colored Laminate Top (specify mfg. & color)	N/A	Natural	Stock Finishes	Custom Match (sample required) Minimum \$403.60
Selection #:	0	A	P	X	0	A	B-N	X

T***22	S	+188	+228	+15%	S	S	+16%	+32%
T***24	S	+188	+228	+15%	S	S	+16%	+32%
T***30	S	+188	+228	+15%		S	+16%	+32%
T***31	S	+188	+228	+15%		S	+16%	+32%
T***35	S	+188	+228	+15%		S	+16%	+32%
T***50	S	+188	+228	+15%		S	+16%	+32%
T***51	S	+188	+228	+15%		S	+16%	+32%
T***85	S	+188	+228	+15%		S	+16%	+32%
T***90	S	+188	+228	+15%	S	S	+16%	+32%
T***91	S	+188	+228	+15%		S	+16%	+32%
T***92	S	+188	+228	+15%		S	+16%	+32%
T***95	S	+188	+228	+15%		S	+16%	+32%
T***96	S	+188	+228	+15%		S	+16%	+32%

NOTES:





Game top is available on 36" square #3 and #4 tops only.

Plywood core and custom colored laminate top is available on top #3 and #4.

TOTAL PRICE = Top Price + Base Price.

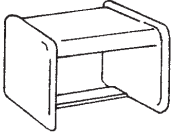
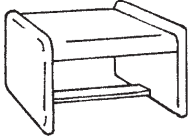
Field Description:							Class Shape			Product Line				Shape		Edge/Base		N/A		N/A			Foam Options			Options/Accessories			Fabric Grade		Fabric Pattern			Wood Type		Finish		Special	
Field Position:							1	2	3	4	5	6	7	8	9	10	11	12	13	14	15	16	17	18	19	20													
							T4	00	0	0	0	-	0	0	00	-	X	000	0	X	0																		

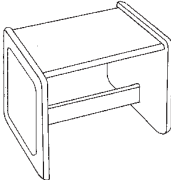
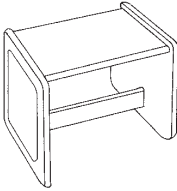
Occasional Tables

	Model/Description	Dimensions	Yd.	Wt.	List Price
	T410110-0000-00001<u>A</u>0 Endurance, End Table Butcher block ends and top, bull nosed edge, oak, natural finish	23½W 24D 20H 7.2 cu. ft.		60	693
	T410210-0000-00001<u>A</u>0 Endurance, Corner Table Butcher block ends and top, bull nosed edge, oak, natural finish	27½W 28D 15H 7.4 cu. ft.		60	752
	T410310-0000-00001<u>A</u>0 Endurance, Coffee Table Butcher block ends and top, bull nosed edge, oak, natural finish	47½W 18D 15H 8 cu. ft.		55	693
	T411110-0000-00001<u>A</u>0 Endurance, Traditional End Table Butcher block ends and top, bull nosed edge, oak, natural finish	23½W 24D 20H 7.2 cu. ft.		60	806
	T411210-0000-00001<u>A</u>0 Endurance, Traditional Corner Table Butcher block ends and top, bull nosed edge, oak, natural finish	27½W 28D 15H 7.4 cu. ft.		60	863
	T411310-0000-00001<u>A</u>0 Endurance, Traditional Coffee Table Butcher block ends and top, bull nosed edge, oak, natural finish	47½W 18D 15H 8 cu. ft.		55	806

Occasional Tables

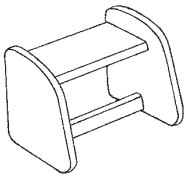
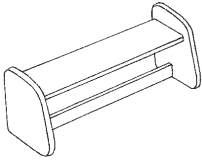
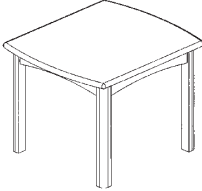
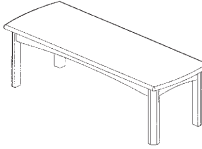
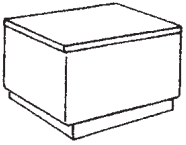
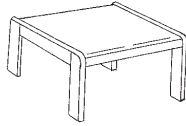
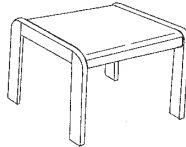
	Model/Description	Dimensions	Yd.	Wt.	List Price
	T412110-0000-00001A0 Bravura End Table Butcher block ends and top, bull nosed edge, oak, natural finish	23½W 24D 20H 7.2 cu. ft.		55	693
	T412310-0000-00001A0 Bravura Coffee Table Butcher block ends and top, bull nosed edge, oak, natural finish	47½W 18D 15H 8 cu. ft.		50	693
	T424100-00A0-00001A0 Arcadia End Table Laminate top, 2mm PVC edge, oak, natural finish, solid oak top option required for staining	27W 24D 20H 8.6 cu. ft.		25	503
	T424300-00A0-00001A0 Arcadia Coffee Table Laminate top, 2mm PVC edge, oak, natural finish, solid oak top option required for staining	50W 18D 15H 9 cu. ft.		30	576
	T430110-0100-****000 Paragon End Table Upholstered base, Cal 117 foam, self-edge laminate top	24W 30D 14H 6.8 cu. ft.	1½	30	A 888 B 925 C 968 D 998 E 1072 F 1145
	T440110-0010-00001A0 Synergy End Table, Leg Base Oak veneer top, 2mm PVC oak edge, oak, natural finish	24W 24D 20½H 7.2 cu. ft.		26	445
	T440210-0010-00001A0 Synergy Corner Table, Leg Base Oak veneer top, 2mm PVC oak edge, oak, natural finish	28W 28D 22H 11.2 cu. ft.		29	514

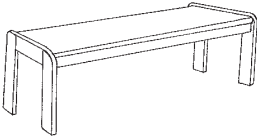
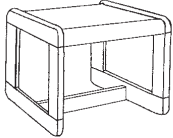
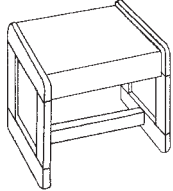
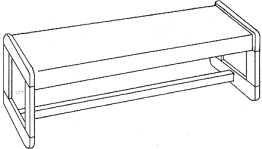
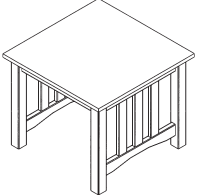
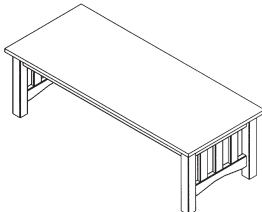

An underlined character indicates there is a choice available. See page 40 for selections and pricing. **** means that a fabric selection is required. List price for C.O.M. material is the same as Grade B. Cartoning charges: Add \$39 to list price per each cartoned occasional table.

Occasional Tables

	Model/Description	Dimensions	Yd.	Wt.	List Price
	T440310-00<u>10</u>-00001<u>A</u>0 Synergy Coffee Table, Leg Base Oak veneer top, 2mm PVC oak edge, oak, natural finish	48W 18D 15½H 8 cu. ft.		32	510
		Wood grain laminate top also available.			
	T441110-00<u>10</u>-00001<u>A</u>0 Synergy End Table, Sled Base Oak veneer top, 2mm PVC oak edge, oak, natural finish	24W 24D 20½H 7.2 cu. ft.		29	539
		Wood grain laminate top also available.			
	T441210-00<u>10</u>-00001<u>A</u>0 Synergy Corner Table, Sled Base Oak veneer top, 2mm PVC oak edge, oak, natural finish	28W 28D 22H 11.2 cu. ft.		36	587
		Wood grain laminate top also available.			
	T441310-00<u>10</u>-00001<u>A</u>0 Synergy Coffee Table, Sled Base Oak veneer top, 2mm PVC oak edge, oak, natural finish	48W 18D 15½H 8 cu. ft.		37	600
		Wood grain laminate top also available.			
	T450100-00<u>10</u>-00001<u>A</u>0 Tucson End Table Oak veneer top, oak, natural finish	24W 24D 20H 7.2 cu. ft.		25	638
		Wood grain laminate top also available. Oak veneer top option required for staining.			
	T450300-00<u>10</u>-00001<u>A</u>0 Tucson Coffee Table Oak veneer top, oak, natural finish	48W 20D 15H 9.5 cu. ft.		30	677
		Wood grain laminate top also available. Oak veneer top option required for staining.			

An underlined character indicates there is a choice available. See page 40 for selections and pricing. **** means that a fabric selection is required. List price for C.O.M. material is the same as Grade B. Cartoning charges: Add \$39 to list price per each cartoned occasional table.

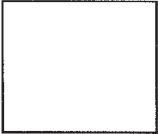
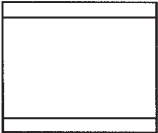
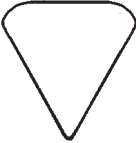
Modular Tables

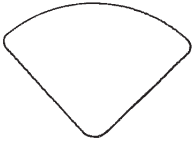
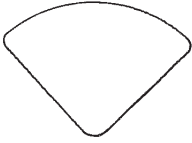
	Model/Description	Dimensions	Yd.	Wt.	List Price
	T512000-0000-0000000 Modular, 24" Spacer Self-edge laminate top Laminate will match natural oak finish unless otherwise specified.	24W 23½D 1 cu. ft.		18	174
	T515000-0000-00001A0 Modular, 24" Spacer Butcher block top, bull nosed edge, oak, natural finish	24W 23½D 1 cu. ft.		22	333
	T522000-0000-0000000 Modular, 45° Wedge Self-edge laminate top Laminate will match natural oak finish unless otherwise specified.	23W 24D 1 cu. ft.		10	244
	T525000-0000-00001A0 Modular, 45° Wedge Butcher block top, bull nosed edge, oak, natural finish	23W 24D 1 cu. ft.		13	325
	T532000-0000-0000000 Modular, 90° Wedge Self-edge laminate top Laminate will match natural oak finish unless otherwise specified.	43½W 26D 1.5 cu. ft.		24	400
	T535000-0000-00001A0 Modular, 90° Wedge Butcher block top, bull nosed edge, oak, natural finish	43½W 26D 1.5 cu. ft.		26	506

An underlined character indicates there is a choice available. See page 40 for selections and pricing. **** means that a fabric selection is required. List price for C.O.M. material is the same as Grade B. Cartoning charges: Add \$39 to list price per each cartoned occasional table.

Field Description:	Class Shape	Product Line	Shape	Edge/Base	N/A	N/A	Foam Options	Options/Accessories	Fabric Grade	Fabric Pattern	Wood Type	Finish	Special
Field Position:	1 2	3 4	5	6	7	8	9 10	11 12	13	14	15 16 17	18	19 20
	T4	00	0	0	0	-	0	0	00	-	X	000	0 X 0

Occasional/Modular Tables

Option Selection & Pricing Guide

Field Description:	Edge/ Base 6		Options 11, 12				Finish 19			
Field Position:										
Selection Description:	N/A	Bull Nosed Edge/ Upholstered Base (T430)	N/A	Solid Oak Top	Plywood Core Laminate Top	Custom Colored Laminate Top (specify mfg. & color)	N/A	Natural	Stock Finishes	Custom Match (sample required) Minimum \$403.60
Selection #:	0	1	0	1	P	X	0	A	B-G	X

T410		S	S					S	+145	+290
T411		S	S					S	+145	+290
T412		S	S					S	+145	+290
T424	S		S	+24	+114	+99		S	+157	+314
T430		S	S			+99		S		
T440		S	S		+114	+99		S	+157	+314
T441		S	S		+114	+99		S	+157	+314
T450	S		S						+157	+314

T512000			S			+99		S		
T515000			S					S	+157	+314
T522000			S			+99		S		
T525000			S					S	+157	+314
T532000			S			+99		S		
T535000			S					S	+157	+314

C9 Casegoods

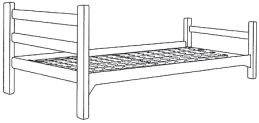
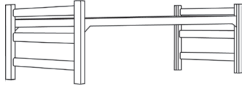
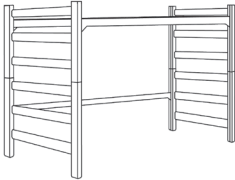
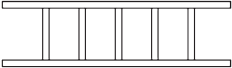
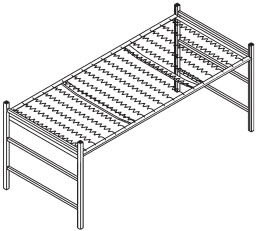
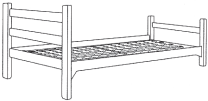
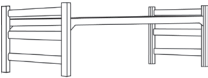
	Model/Description	Dimensions	Yd.	Wt.	List Price
	C170140-<u>0000</u>-00001A0 C7 Adjustable Bed 2½ x 2½ posts, oak, natural finish each bed includes headboard/footboard set, 36 x 80 springs	38¾W 85D 36H 15.5 cu. ft.		73	645
	C170141-<u>0000</u>-00001A0 C7 Adjustable Bed Low Loft 2½ x 2½ posts, oak, natural finish each bed includes two headboards, 36 x 80 springs	38¾W 85D 36H 16.5 cu. ft.		79	666
	C170142-<u>0000</u>-00001A0 C7 Adjustable Bed Full Height Loft 2½ x 2½ posts, oak, natural finish each bed includes four headboards, 36 x 80 springs, four stacking pins, four nylon ties and one stabilizer rail	38¾W 85D 72H 22.5 cu. ft.		129	1147
	C170700-<u>0000</u>-00001A0 C7 Bed Ladder Oak, natural finish	17W 3½D 67H 2.9 cu. ft.		25	333
	C180150-<u>0000</u>-0000000 CL Adjustable Height Bed Steel posts, each bed includes two headboards and 36 x 80 springs	37¾W 83D 37½H 16.5 cu. ft.		129	985
	C190160-<u>0000</u>-00001A0 Adjustable Channel Bed 2.5" x 2.5" posts, oak, natural finish, includes headboard/footboard set, 36" x 80" spring	38¾W 85D 36H 15.5 cu. ft.		73	821
	C190161-<u>0000</u>-00001A0 Adjustable Low Loft Channel Bed 2.5" x 2.5" posts, oak, natural finish, includes two headboards, 36" x 80" spring	38¾W 85D 36H 16.5 cu. ft.		80	873

An underlined character indicates there is a choice available. See pages 52-53 for selections and pricing. Cartoning charges: Add \$22 to list price per each cartoned ladder and headboard; Add \$38 to list price per each cartoned bed set; Add \$66 to list price per each cartoned captain's bed; Add 10% to list price per any other cartoned C1 item.

C9 Casegoods

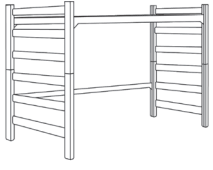
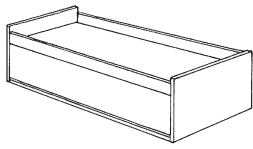
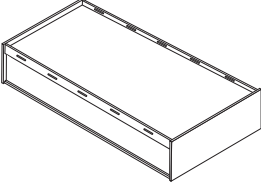
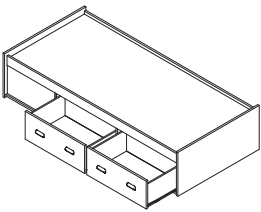
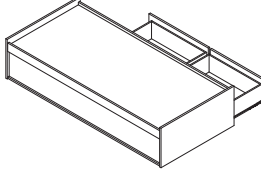
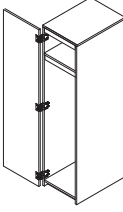
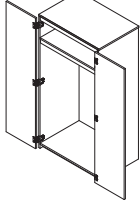
	Model/Description	Dimensions	Yd.	Wt.	List Price
	C190142-<u>0000</u>-00001A0 Adjustable Full Height Loft Channel Bed 2.5" x 2.5" posts, oak, natural finish, includes four headboards, 36" x 80" spring, four stacking pins, stabilizer rail, four bed post brackets	38.75W 85D 72H 22.5 cu. ft.		130	1575
	C190400-0000-00001A0 Captain's Bed w/out Drawers Oak, natural finish, accommodates 36 X 80 mattress	82W 39D 16½H 33.5 cu. ft.		115	1082
	C190402-0000-00001A0 C9 Captain's Bed w/ (5) Restraint Slots Oak, natural finish, accomodates 36 x 80 mattress	82W 39D 18H 36.5 cu. ft.		115	1305
	C190411-P000-00001A0 Captain's Bed Two right side facing drawers, oak, natural finish, oak pulls, accommodates 36 X 80 mattress	82W 39D 16½H 33.5 cu. ft.		145	1227
	C190412-P000-00001A0 Captain's Bed Two left side facing drawers, oak, natural finish, oak pulls, accommodates 36 X 80 mattress	82W 39D 16½H 33.5 cu. ft.		145	1227
	C290100-P000-00001A0 Single Wardrobe Shelf, closet rod, oak, natural finish, oak pulls, laminate top	18½W 25D 72H 21.5 cu. ft.		115	863
	C290200-P000-00001A0 Double Wardrobe Shelf, closet rod, oak, natural finish, oak pulls, laminate top	36½W 25D 72H 41.2 cu. ft.		175	1205

An underlined character indicates there is a choice available. See pages 52-53 for selections and pricing. Cartoning charges: Add \$60 to list price per each cartoned chest unit; Add \$66 to list price per any other cartoned C2 item; Add \$66 to list price per each cartoned captain's bed; Add \$38 to list price per each cartoned nightstand.

C9 Casegoods

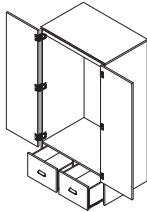
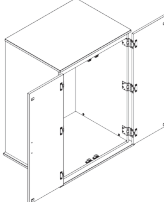
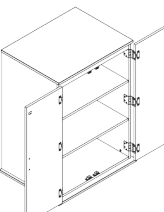
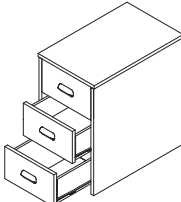
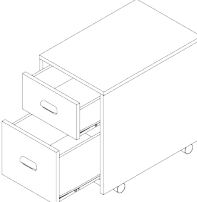
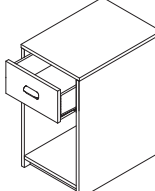
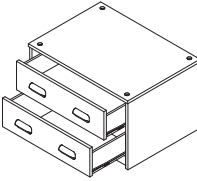
	Model/Description	Dimensions	Yd.	Wt.	List Price
	C290250-P000-00001A0 Double Wardrobe w/two Drawers Closet rod, oak, natural finish, oak pulls, laminate top	36½W 25D 72H 41.2 cu. ft.		180	1337
	C290300-P000-00001A0 C9 Wardrobe Space Saver Upper Unit Oak, natural finish, upper storage unit w/closet rod, for use with the desk/chest unit	31.75W 24.25D 42.5H 20.8 cu. ft.		118	839
	C290310-P000-00001A0 C9 Storage Space Saver Upper Unit Oak, natural finish, upper storage unit w/shelves, for use with the desk/chest unit	31.75W 24.25D 42.5H 20.8 cu. ft.		118	959
	C290400-P000-00001A0 Three Drawer Wardrobe Chest Fits inside wardrobe, oak, natural finish, oak pulls, laminate top	16W 22D 26H 6.2 cu. ft.		60	536
	C290402-P000-00001A0 Two Drawer Mobile Pedestal w/Casters Oak, natural finish, oak pulls, laminate top *Bolt on casters to be field installed.	16W 22D 24½H 5.8 cu. ft.		55	533
	C290410-P000-00001A0 One Drawer Night Stand Oak, natural finish, oak pulls, laminate top	16W 22D 24H 5.7 cu. ft.		50	407
	C290425-P000-00001A0 Two Drawer Stackable Unit Oak, natural finish, oak pulls, laminate top, top drilled for stacking	30½W 24D 19H 9 cu. ft.		80	554

An underlined character indicates there is a choice available. See pages 52-53 for selections and pricing. Cartoning charges: Add \$22 to list price per each cartoned mirror; Add \$60 to list price per each cartoned chest unit; Add \$66 to list price per any other cartoned C2 or C3 item.

C9 Casegoods

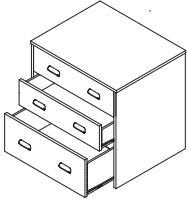
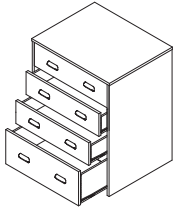
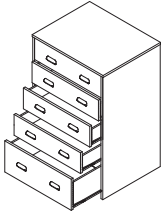
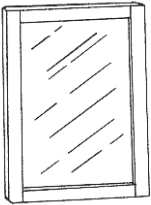
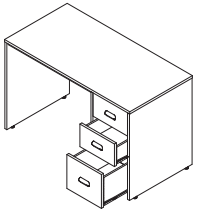
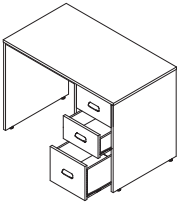
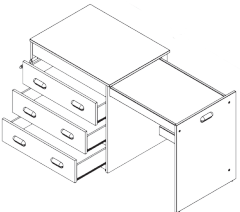
	Model/Description	Dimensions	Yd.	Wt.	List Price
	C290430-P000-00001A0 Three Drawer Chest Oak, natural finish, oak pulls, laminate top	30½W 24D 30H 14.2 cu. ft.		120	726
	C290440-P000-00001A0 Four Drawer Chest Oak, natural finish, oak pulls, laminate top	30½W 24D 38H 17.8 cu. ft.		150	934
	C290450-P000-00001A0 Five Drawer Chest Oak, natural finish, oak pulls, laminate top	30½W 24D 45H 21 cu. ft.		180	1103
	C270700-0000-00001A0 Framed Wall Mirror Oak, natural finish C270710-0000-00001A0 Optional safety glass (plexiglass) Oak, natural finish	22W 1½D 36H 1 cu. ft.		23	216 326
	C390120-P000-00001A0 48" Desk w/ File Drawer File drawer, two box drawers, oak, natural finish, oak pulls, laminate top C390120-PD00-00001A0 knee-hole keyboard/mouse pad tray	48W 24D 30H 22 cu. ft.		105	761 822
	C390125-P000-00001A0 42" Desk w/ File Drawer File drawer, two box drawers, oak, natural finish, oak pulls C390125-PD00-00001A0 knee-hole keyboard/mouse pad tray	42W 24D 30H 19.3 cu. ft.		102	761 822
	C390150-P000-00001A0 C9 Desk/Chest Space Saver Oak, natural finish, 3 drawer dresser, extendable work area	31.75W 24.25D 30.75H 56.75W (when workstation is open) 15.1 cu. ft.		120	1257

C9 Casegoods

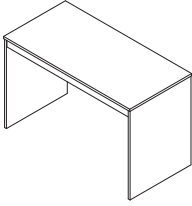
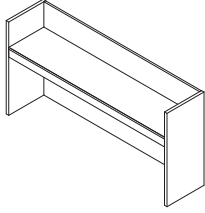
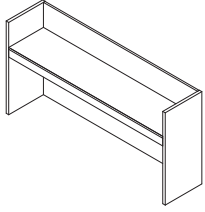
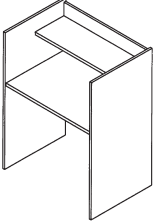
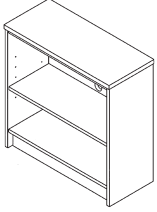
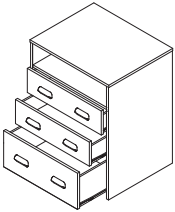
	Model/Description	Dimensions	Yd.	Wt.	List Price
	C390200-0000-00001A0 48" Panel End Writing Desk Oak, natural finish, laminate top	48W 24D 30H 22 cu. ft.		95	494
	C390205-0000-00001A0 42" Panel End Writing Desk Oak, natural finish, laminate top	42W 24D 30H 19.3 cu. ft.		90	480
	C390310-0000-00001A0 48" Bookcase/Carrel ¾" end panels, one shelf with 16" clearance, includes desk attachment pins, wire access hole, oak, natural finish	47¾W 11D 24H 8.6 cu. ft.		35	310
	C390310-E000-00001A0 Florescent light				347
	C390315-0000-00001A0 42" Bookcase/Carrel ¾" end panels, one shelf with 16" clearance, includes desk attachment pins, wire access hole, oak, natural finish	41¾W 11D 24H 7.5 cu. ft.		35	310
	C390315-E000-00001A0 Florescent light				347
	C390320-0000-00001A0 Study Carrel Scratch resistant writing surface, wire access hole, oak, natural finish	36W 24D 47H 25.2 cu. ft.		80	666
	C390420-0000-00001A0 30" Bookcase Adjustable shelf, wire access hole, oak, natural finish, laminate top	30½W 13D 30H 8 cu. ft.		45	439
	C390570-P000-00001A0 Entertainment Chest Three drawers, fixed shelf, wire access hole, oak, natural finish, oak pulls, laminate top	30½W 24D 38H 17.8 cu. ft.		135	916
	Hardware for field installation: AC74825 (Single) Padlock eyes, hardware included AC74826 (Double) Padlock eyes, hardware included AC74827 (Glass) Wardrobe mirror, hardware included AC74831 CS shelf kit for wardrobes & TV unit				43 43 79 69

An underlined character indicates there is a choice available. See pages 52-53 for selections and pricing. Cartoning charges: Add \$60 to list price per each cartoned chest unit; Add \$66 to list price per any other cartoned C3 item.

CS Casegoods

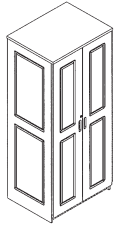
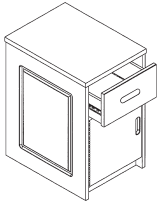
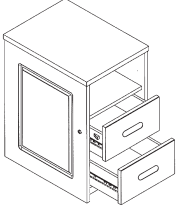
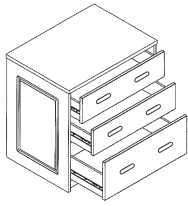
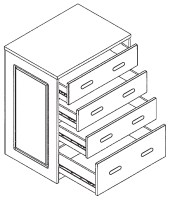
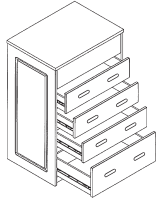
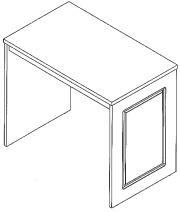
	Model/Description	Dimensions	Yd.	Wt.	List Price
	C230200-0000-00001A0 30" Wardrobe 270° piano hinge, key lock, J-bar, shelf, oak, natural finish, laminate top, optional wheelchair accessible pull latch	30½W 23½D 72½H 32.9 cu. ft.		225	2343
	C230411-0000-00001A0 Nightstand w/One Drawer and One Door Positive stop drawer, 180° piano hinge, oak, natural finish, laminate top	16W 21¼D 26¾H 6.1 cu. ft.		65	683
	C230413-0000-00001A0 Nightstand w/Two Drawers Open top shelf, positive stop drawers, key lock top drawer, oak, natural finish, laminate top	16W 21¼D 26¾H 6.1 cu. ft.		70	698
	C230430-0000-00001A0 Chest w/Three Drawers Positive stop drawers, oak, natural finish, laminate top	30½W 22D 30½H 13.2 cu. ft.		135	1032
	C230440-0000-00001A0 Chest w/Four Drawers Positive stop drawers, oak, natural finish, laminate top	30½W 22D 38H 16.4 cu. ft.		160	1267
	C230450-0000-00001A0 Chest w/Five Drawers Positive stop drawers, oak, natural finish, laminate top	30½W 22D 45¾H 19.6 cu. ft.		190	1487
	C330200-0000-00001A0 Writing Desk Oak, natural finish, laminate top	36½W 22D 30½H 15.8 cu. ft.		80	543

An underlined character indicates there is a choice available. See pages 52-53 for selections and pricing. Cartoning charges: Add \$38 to list price per each cartoned nightstand; Add \$60 to list price per each cartoned chest unit; Add \$66 to list price per any other cartoned C2 or C3 item.

CS Casegoods

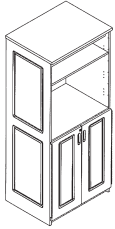
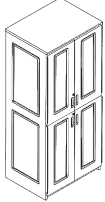
	Model/Description	Dimensions	Yd.	Wt.	List Price
	C330560-<u>Q</u>000-00001A0 TV/Armoire w/Two Doors 270° piano hinge, key lock, two adjustable shelves, wire access ports, oak, natural finish, laminate top	30½W 23½D 72½H 32.9 cu. ft. (opening size: 28½W 18⅞D 30⅞H)		205	2015
	C330560-<u>F</u>000-00001A0 TV/Armoire w/Four Doors 270° piano hinge, key lock, two adjustable shelves, wire access ports, oak, natural finish, laminate top	30½W 23½D 72½H 32.9 cu. ft. (opening size: 28½W 18⅞D 30⅞H)		215	2352

Vista Casegoods

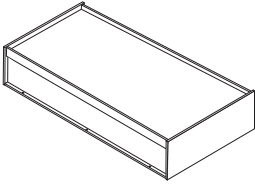
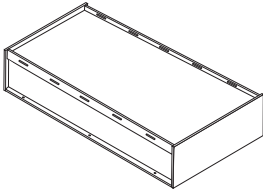
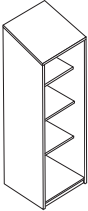
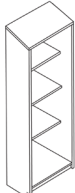
	Model/Description	Dimensions	Yd.	Wt.	List Price
	C110400-0000-00001A0 Captain's Bed Oak, natural finish, accommodates 36 x 80 mattress, anchor points for stationary positioning	82W 39D 16½H 33.5 cu. ft.		115	1147
	C110402-0000-00001A0 Vista Captain's Bed w/ (5) Restraint Slots Oak, natural finish, accommodates 36 x 80 mattress, anchor points for stationary positioning	82W 39D 18H 36.5 cu. ft.		115	1370
	C210100-0000-00001A0 Single 24" Depth Wardrobe Oak, natural finish, fixed recessed shelves, laminate sloped top	24½W 24D 78H 29 cu. ft.		130	1282
	C210105-0000-00001A0 Single 12" Depth Wardrobe Oak, natural finish, fixed recessed shelves, laminate sloped top	24½W 12D 78H 15.2 cu. ft.		75	1056



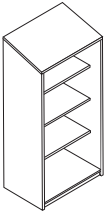
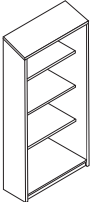
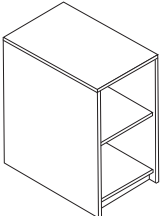
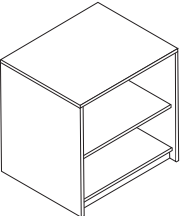
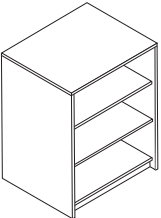
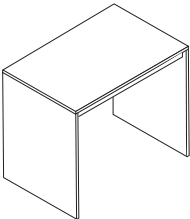

An underlined character indicates there is a choice available. See pages 52-53 for selections and pricing. Cartoning charges: Add \$38 to list price per each cartoned nightstand; Add \$60 to list price per each cartoned chest unit; Add \$66 to list price per any other cartoned C2 or C3 item.

Vista Casegoods

	Model/Description	Dimensions	Yd.	Wt.	List Price
	C210200-0000-00001A0 Double 24" Depth Wardrobe Oak, natural finish, fixed recessed shelves, laminate sloped top	36½W 24D 78H 42.8 cu. ft.		170	1394
	C210205-0000-00001A0 Double 12" Depth Wardrobe Oak, natural finish, fixed recessed shelves, laminate sloped top	36½W 12D 78H 22.3 cu. ft.		100	1127
	C210410-0000-00001A0 Nightstand Oak, natural finish, fixed shelf, laminate top	16W 22D 24H 5.7 cu. ft.		45	538
	C210430-0000-00001A0 Chest w/Two Shelves Oak, natural finish, fixed shelves, laminate top	30½W 24D 30H 14.2 cu. ft.		80	709
	C210440-0000-00001A0 Chest w/Three Shelves Oak, natural finish, fixed shelves, laminate top	30½W 24D 38H 17.8 cu. ft.		100	837
	C310200-0000-00001A0 Writing Desk Oak, natural finish, laminate top	36½W 24D 30H 16.1 cu. ft.		65	617

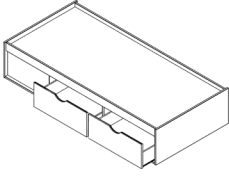
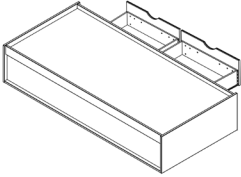

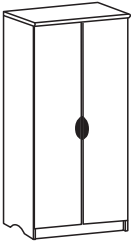
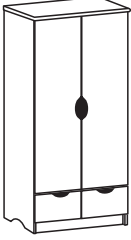

An underlined character indicates there is a choice available. See page 52 for selections and pricing. Add \$38 to list price per each cartoned nightstand. Add \$60 to list price per each cartoned chest unit. Add \$66 to list price on any other C2 item or cartoned Captain's bed.

Spartan Casegoods

	Model/Description	Dimensions	Yd.	Wt.	List Price
	C190411-P000-00001A0 Captain's Bed Two right side facing drawers, oak, natural finish, oak pulls, accommodates 36 X 80 mattress	82W 39D 16½H 33.5 cu. ft.		147	1227
	C190412-P000-00001A0 Captain's Bed Two left side facing drawers, oak, natural finish, oak pulls, accommodates 36 X 80 mattress	82W 39D 16½H 33.5 cu. ft.		147	1227
	C295100-0000-00001A0 Single Wardrobe Shelf, closet rod, oak, natural finish, half moon pulls, laminate top	18½W 25D 72H 21.5 cu. ft.		115	863
	C295200-0000-00001A0 Double Wardrobe Shelf, closet rod, oak, natural finish, half moon pulls, laminate top	36½W 25D 72H 41.2 cu. ft.		175	1205
	C295250-0000-00001A0 Double Wardrobe w/two Drawers Closet rod, oak, natural finish, half moon pulls, laminate top	36½W 25D 72H 41.2 cu. ft.		180	1337
	C295400-0000-00001A0 Three Drawer Wardrobe Chest Fits inside wardrobe, oak, natural finish, half moon pulls, laminate top	16W 22D 26H 6.2 cu. ft.		60	536
	C295402-0000-00001A0 Two Drawer Mobile Pedestal w/Casters Oak, natural finish, half moon pulls, laminate top	16W 22D 24H 5.8 cu. ft.		55	533

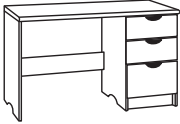
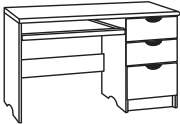

Cartoning charges: Add \$38 to list price per each cartoned nightstand; Add \$60 to list price per each cartoned chest unit; Add \$66 to list price on any other C2 item.

Spartan Casegoods

	Model/Description	Dimensions	Yd.	Wt.	List Price
	C295410-0000-00001A0 One Drawer Night Stand Oak, natural finish, half moon pulls, laminate top	16W 22D 24H 5.7 cu. ft.		50	407
	C295425-0000-00001A0 Two Drawer Stackable Unit Oak, natural finish, half moon pulls, laminate top	30½W 24D 19H 9.0 cu. ft.		80	571
	C295430-0000-00001A0 Three Drawer Chest Oak, natural finish, half moon pulls, laminate top	30½W 24D 30H 14.2 cu. ft.		120	726
	C295440-0000-00001A0 Four Drawer Chest Oak, natural finish, half moon pulls, laminate top	30½W 24D 38H 17.8 cu. ft.		150	934
	C295450-0000-00001A0 Five Drawer Chest Oak, natural finish, half moon pulls, laminate top	30½W 24D 45H 21.0 cu. ft.		180	1103
	C395120-0000-00001A0 48" Desk File drawer, two box drawers, oak, natural finish, half moon pulls, laminate top	48W 24D 30H 22.0 cu. ft.		105	761
	C395120-D000-00001A0 48" Desk w/ Computer Tray File drawer, two box drawers, oak, natural finish, half moon pulls, laminate top	48W 24D 30H 22.0 cu. ft.		110	822

Cartoning charges: Add \$60 to list price per each cartoned chest unit; Add \$66 to list price of any other C3 item.

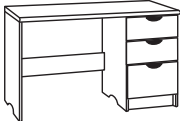
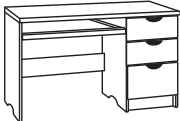
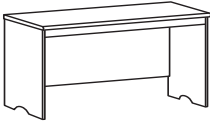
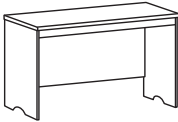
Spartan Casegoods

	Model/Description	Dimensions	Yd.	Wt.	List Price
	C395125-0000-00001A0 42" Desk File drawer, two box drawers, oak, natural finish, half moon pulls	42W 24D 30H 19.3 cu. ft.		102	761
	C395125-D000-00001A0 42" Desk w/ Computer Tray File drawer, two box drawers, oak, natural finish, half moon pulls	42W 24D 30H 19.3 cu. ft.		106	822
	C395200-0000-00001A0 48" Panel End Writing Desk Oak, natural finish, laminate top	48W 24D 30H 22.0 cu. ft.		95	494
	C395205-0000-00001A0 42" Panel End Writing Desk Oak, natural finish, laminate top	42W 24D 30H 19.3 cu. ft.		90	480
	C395310-0000-00001A0 48" Bookcase/Carrel ¾" end panels, one shelf with 16" clearance, includes desk attachment pins, wire access hole, oak, natural finish	47¾W 11D 24H 8.6 cu. ft.		35	310
	C395310-E000-00001A0 w/ fluorescent light				347
	C395315-0000-00001A0 42" Bookcase/Carrel ¾" end panels, one shelf with 16" clearance, includes desk attachment pins, wire access hole, oak, natural finish	41¾W 11D 24H 7.5 cu. ft.		35	310
	C395315-E000-00001A0 w/ fluorescent light				347

Cartoning charges: Add \$66 to list price per any other C3 item.

	Class Type		Product Line		Product Description		N/A		Options/ Accessories				N/A		N/A		Wood Type	Finish	Special	
Field Description:	1	2	3	4	5	6	7	8	9	10	11	12	13	14	15	16	17	18	19	20
Field Position:	C3		00		00		0	-	0000				-	0	000		0	X	0	

Casegood Option Selection & Pricing Guide

Field Description:	Options										
Field Position:	9, 10, 11, 12										
Selection Description:	N/A	36 x 76 Spring	Wheelchair Accessible Pull Latch	Computer Tray	Fluorescent Light / Bed Liner	Upper Doors	Wood Pulls	Optional Base	Optional Top	C7 Pulls	Heavy Duty Sliders (per drawer)
Selection #:	0	A	B	D	E	F	P	S	T	W	D

C170140	S	+6									
C170141	S	+6									
C180150	S										
C190400	S				+556						
C190411	S				+556		S			+53	+199
C190412	S				+556		S			+53	+199
C195411										+53	+199
C195412										+53	+199
C230200			+50								
C290100							S	+126	+43		
C290200							S	+142	+66		
C290250							S	+142	+66	+45	
C290400							S	+126	+43	+40	
C290402							S		+43	+40	
C290410							S	+126	+43	+14	
C290425							S	+136	+60	+40	
C290430							S	+136	+60	+53	
C290440							S	+136	+60	+66	
C290450							S	+136	+60	+76	
C330560	S					+443.					
C390120				+82			S	+126	+75	+40	
C390125				+82			S	+126	+75	+40	
C390200	S							+75			

Casegood Option Selection & Pricing Guide

Field Description:	Options									
Field Position:	9, 10, 11, 12									
Selection Description:	N/A	36 x 76 Spring	Wheelchair Accessible Pull Latch	Computer Tray	Fluorescent Light / Bed Liner	Upper Doors	Wood Pulls	Optional Base	Optional Top	C7 Pulls
Selection #:	0	A	B	D	E	F	P	S	T	W

C390205									+75	
C390310	S				+45					
C390315	S				+45					
C390420	S							+118	+43	
C390570							S	+136	+60	+53
C395120	S			+82						
C395125	S			+82						
C395310	S				+45					
C395315	S				+4					

C9 Space Saver Casegood Option Selection & Pricing Guide



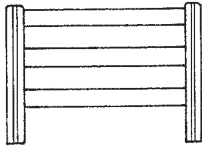
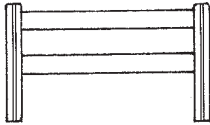
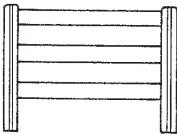
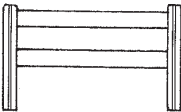
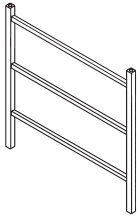
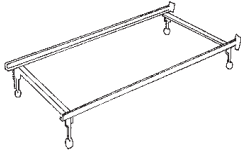
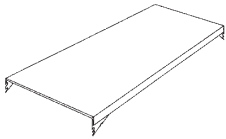

Field Description:	Options					
Field Position:	9		10, 11, 12			
Selection Description:	Wood Pulls	C7 Pulls	N/A	No Top	Spill Retention Top	Electric Outlet
Selection #:	P	W	O	N	F	V

C390150		+56.	S			+115.
C290300			S		+66.	+115.
C290310			S		+66.	+115.

Casegood Assemblies/Parts

	Model/Description	Dimensions	Yd.	Wt.	List Price
	AC74050-0000-00001A0 C7 Adjustable Height Headboard 2½" x 2½" posts, oak, natural finish	38¾W 2½D 36H 2.6 cu. ft.		20	219
	AC74051-0000-00001A0 C7 Adjustable Height Footboard 2½" x 2½" posts, oak, natural finish	38¾W 2½D 24H 1.8 cu. ft.		14	177
	AC74055-0000-00001A0 Adjustable Height Channel Headboard 2.5" x 2.5" posts, oak, natural finish	38.75W 2½D 36H 2.6 cu. ft.		20	294
	AC74056-0000-00001A0 Adjustable Height Channel Footboard 2.5" x 2.5" posts, oak, natural finish	38.75W 2½D 24H 1.8 cu. ft.		14	247
	AC74080-0000-0000000 CL Adjustable Height Headboard Steel posts, black finish	37¾W 1½D 37½H 2.6 cu. ft.		17	338
	AC74370-0000-0000000 Metal Bed Frame Expands form twin to queen size Not compatible with adjustable height headboard and footboard	76L 1.1 cu. ft.		26	153
	AC74811-0000-0000000 Plywood Deck with Rails Accommodates 36" x 80" mattress, includes two metal rails and plywood deck for use with adjustable height bed only	36W 80L 2.6 cu. ft.			327

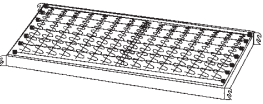
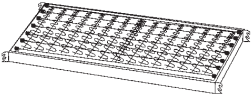
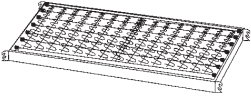
Casegood Assemblies/Parts

	Model/Description	Dimensions	Yd.	Wt.	List Price
	AC74815-0000-00001A0 Safety Rails Oak, natural finish, available for 80" long mattress only	83¾L .9 cu. ft.		10	145
	AC74822-0000-0000000 Bunking Hardware Includes four pins and four nylon ties				6
	AC74823-0000-0000000 Bunking Hardware Includes four pins, four bed post brackets				48
	45804 Bed Spring - Adjustable Height Accommodates 36" x 76" mattress for use with adjustable height bed only 76" mattress size	36W 78L 11.0 cu. ft.		34	341
	45805 Bed Spring - Adjustable Height Accommodates 36" x 80" mattress for use with adjustable height bed only 80" mattress size	36W 82L 11.0 cu. ft.		39	338
	45815 Bed Spring for the Adjustable Channel Bed Accommodates 36" x 80" mattress for use with adjustable height channel bed only	36W 82L 11 cu. ft.		39	290
	45865 Stabilizing Rail Adjustable w/Posi-Locks Available for 80" long mattress only	82L .9 cu. ft.		10	114

Casegood Assemblies/Parts

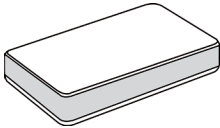
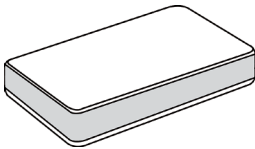
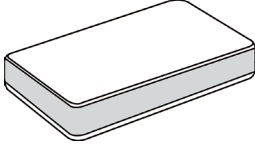
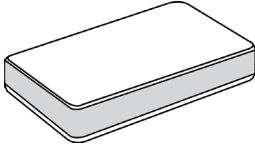
	Model/Description	Dimensions	Yd.	Wt.	List Price
	45875 Stabilizing Rail for the Adjustable Channel Bed Available for 80" long mattress	82L .9 cu. ft.		10	74
	45890 36" Foam Mattress* 36 x 80 recyclable foam mattress with removable moisture resistant breathable cover	36W 80D 5½H 6.5 cu. ft.		21	630
	45891 38" Foam Mattress*	38W 80D 5½H 6.5 cu. ft.		22	643
	45892 Mattress* Vinyl cover; super fibre of densified polyester; seamless, no zipper	36W 80D 4½H 9.5 cu. ft.			292
	45893 Innerspring Mattress* Nylon cover	36W 80D 7H 13.9 cu. ft.			462
	45894 Sealed Seam Foam Mattress* Nylon cover	36W 80D 5H 10.4 cu. ft.			681

All mattresses are bagged. Installation on mattresses is not available. Dock delivery only.



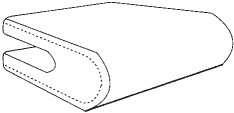
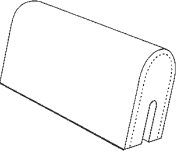
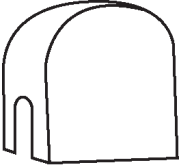
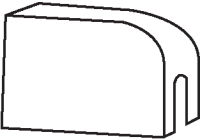
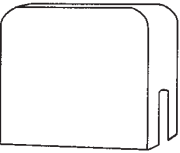
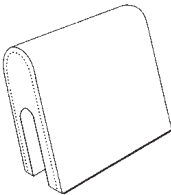

Field Description:		Class Type		Part #		N/A		Foam Options		N/A		Fabric Grade		Fabric Pattern		Wood Type		Finish		Special	
Field Position:		1	2	3	4	5	6	7	8	9	10	11	12	13	14	15	16	17	18	19	20
		AL		00000						0		0		00				X		0	

Lounge Seating Assemblies/Parts

	Model/Description	Dimensions	Yd.	Wt.	List Price
	AL70000-0000-****000 Key-Loc® Seat Cover Deduct 5% when quantity exceeds 25.		2	2	A 212 B 260 C 314 D 353 E 450 F 548
	AL70001-0000-****000 Key-Loc® Back Cover Deduct 5% when quantity exceeds 25.		1½	2	A 178 B 215 C 259 D 288 E 362 F 435
	AL70010-0000-****000 Key-Loc® Contour/Curved Back Cover for Chair Can be used for backs on contour loveseats and sofas		2	2	A 257 B 306 C 365 D 404 E 502 F 599
	AL70011-0000-****000 Key-Loc® Curved Back Cover for Loveseat or Sofa End		2	2	A 257 B 306 C 365 D 404 E 502 F 599
	AL70012-0000-****000 Key-Loc® Curved Back Cover for Sofa Center		2	2	A 257 B 306 C 365 D 404 E 502 F 599
	AL70030-0000-****000 Safety Support Chair Back Cover <i>See AL70000-0000-****000 for seat cover.</i>		2½	2	A 223 B 284 C 357 D 406 E 528 F 650

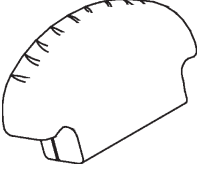
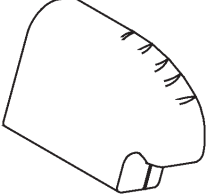
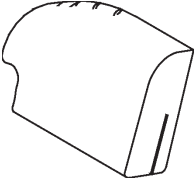
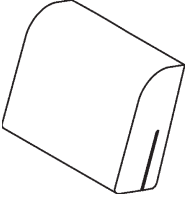
An underlined character indicates there is a choice available. See pages 66-67 for selections and pricing. **** means that a fabric selection is required. List price for C.O.M. material is the same as Grade B.

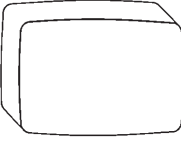
Lounge Seating Assemblies/Parts

	Model/Description	Dimensions	Yd.	Wt.	List Price
	AL70031-0000-****000 Key-Loc® Regent Back Cover for Chair	Not available in vinyl.	2	3	A 306 B 355 C 414 D 453 E 550 F 648
	AL70032-0000-****000 Key-Loc® Regent Back Cover for Right End of Loveseat or Sofa	Not available in vinyl.	2	3	A 306 B 355 C 414 D 453 E 550 F 648
	AL70033-0000-****000 Key-Loc® Regent Back Cover for Left End of Loveseat or Sofa	Not available in vinyl.	2	3	A 306 B 355 C 414 D 453 E 550 F 648
	AL70034-0000-****000 Key-Loc® Regent Back Cover for Center of Sofa	Not available in vinyl.	2	3	A 306 B 355 C 414 D 453 E 550 F 648
	AL70040-<u>K</u>000-****000 Casual Comfort/Tucson/Malibu/ Pomona/Aurora/Haley Seat Cover	Not available in vinyl.	1½	2	A 170 B 207 C 252 D 280 E 354 F 427
	AL70041-<u>K</u>000-****000 Casual Comfort/Tucson/Malibu/ Pomona/Aurora/Haley Back Cover	Not available in vinyl.	1½	1	A 122 B 158 C 203 D 232 E 305 F 378
	AL70055-0000-****000 Sabre/Bristol/Tarvos/Estel/ Eros Chair Seat Cover	Not available in vinyl. Fabric will be railroaded.	1	2	A 156 B 180 C 209 D 229 E 278 F 327





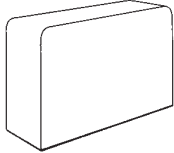
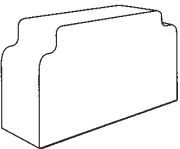
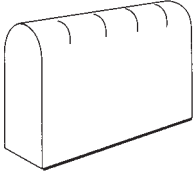
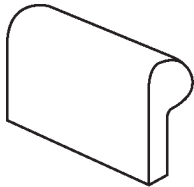
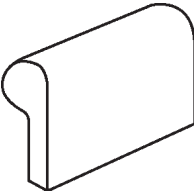
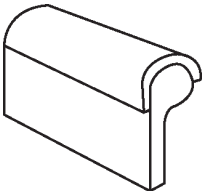

An underlined character indicates there is a choice available. See pages 66-67 for selections and pricing. **** means that a fabric selection is required. List price for C.O.M. material is the same as Grade B.

Lounge Seating Assemblies/Parts

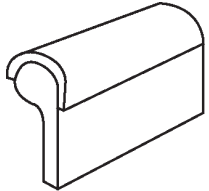
	Model/Description	Dimensions	Yd.	Wt.	List Price
	AL70056-0000-****000 Sabre/Bristol/Tarvos/Estel Eros Sofa Seat Cover	Not available in vinyl. Fabric will be railroaded.	1	2	A 189 B 220 C 257 D 282 E 343 F 404
	AL70100-0000-****000 L420 Ambassador Arm Cover For standard arm panel		1½	5	A 200 B 237 C 282 D 310 E 384 F 457
	AL70101-0000-****000 L422 Ambassador Arm Cover For arm panel with bentply arm cap		1½	5	A 250 B 287 C 332 D 360 E 434 F 507
	AL70102-0000-****000 Aries Arm Cover		1½	5	A 202 B 238 C 283 D 312 E 385 F 458
	AL70105-0000-****000 Ambassador Rolled Right Arm Cover		2	5	A 256 B 305 C 364 D 403 E 500 F 598
	AL70106-0000-****000 Ambassador Rolled Left Arm Cover		2	5	A 256 B 305 C 364 D 403 E 500 F 598
	AL70107-0000-****000 Regent Right Arm Cover		2½	5	A 378 B 439 C 513 D 562 E 684 F 806

An underlined character indicates there is a choice available. See pages 66-67 for selections and pricing. **** means that a fabric selection is required. List price for C.O.M. material is the same as Grade B.

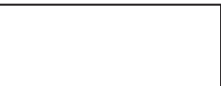
Lounge Seating Assemblies/Parts

	Model/Description	Dimensions	Yd.	Wt.	List Price
	AL70108-0000-****000 Regent Left Arm Cover		2½	5	A 378 B 439 C 513 D 562 E 684 F 806
	AL70120-0000-****000 Ambassador/Regent Fornt Rail Cover for Chair		½	1	A 62 B 74 C 88 D 98 E 123 F 147
	AL70121-0000-****000 Ambassador/Aries/Regent Back Rail Cover for Chair		½	1½	A 73 B 85 C 99 D 109 E 134 F 158
	AL70130-0000-****000 Ambassador/Regent Fornt Rail Cover for Loveseat		½	1½	A 78 B 90 C 105 D 115 E 139 F 164
	AL70131-0000-****000 Ambassador/Aries/Regent Back Rail Cover for Loveseat		¾	2	A 89 B 108 C 129 D 145 E 182 F 218
	AL70140-0000-****000 Ambassador/Regent Fornt Rail Cover for Sofa		1	2	A 106 B 130 C 159 D 179 E 228 F 277
	AL70141-0000-****000 Ambassador/Aries/Regent Back Rail Cover for Sofa		1	2½	A 123 B 147 C 176 D 196 E 245 F 294

An underlined character indicates there is a choice available. See pages 66-67 for selections and pricing. **** means that a fabric selection is required. List price for C.O.M. material is the same as Grade B.

Lounge Seating Assemblies/Parts

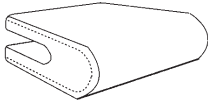
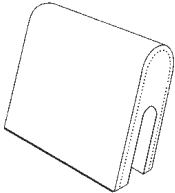
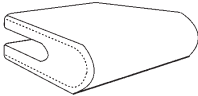
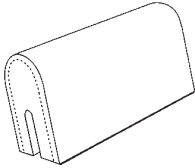
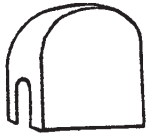
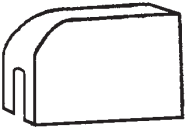
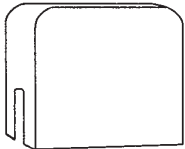
	Model/Description	Dimensions	Yd.	Wt.	List Price
	AL70250-0000-****000 Down-Sized Key-Loc® Seat Cover For retired 8500 series Deduct 5% when quantity exceeds 25.		2	1½	A 206 B 255 C 314 D 353 E 450 F 548
	AL70251-0000-****000 Down-Sized Key-Loc® Back Cover For retired 8500 series Deduct 5% when quantity exceeds 25.		1	1½	A 173 B 197 C 226 D 246 E 295 F 344
	AL70300-0100-****000 Key-Loc® Seat Cushion Upholstered, Cal 117 foam Deduct 5% when quantity exceeds 25.		2	15	No cover: 395 A 467 B 516 C 575 D 614 E 712 F 809
	AL70301-0100-****000 Key-Loc® Back Cushion Upholstered, Cal 117 foam Deduct 5% when quantity exceeds 25.		1½	10	No cover: 284 A 362 B 398 C 443 D 472 E 545 F 618
	AL70310-0100-****000 Key-Loc® Contour/Curved Back Cushion Upholstered, Cal 117 foam		2	10	A 462 B 510 C 569 D 608 E 706 F 804
	AL70311-0100-****000 Key-Loc® Curved Back Cushion for Loveseat or Sofa End Upholstered, Cal 117 foam		2	10	A 462 B 510 C 569 D 608 E 706 F 804
	AL70312-0100-****000 Key-Loc® Curved Back Cushion for Sofa Center Upholstered, Cal 117 foam		2	10	A 462 B 510 C 569 D 608 E 706 F 804

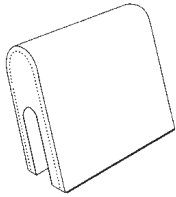
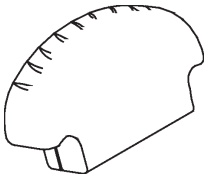
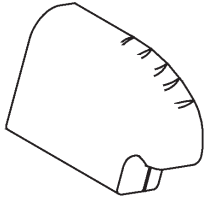
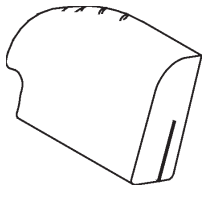
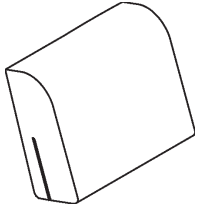
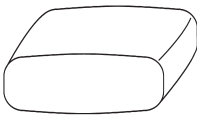
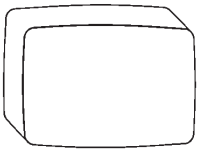

An underlined character indicates there is a choice available. See pages 66-67 for selections and pricing. **** means that a fabric selection is required. List price for C.O.M. material is the same as Grade B.

Lounge Seating Assemblies/Parts

	Model/Description	Dimensions	Yd.	Wt.	List Price
	AL70330-0<u>1</u>00-****000 Safety Support Chair Back Cushion Upholstered, Cal 117 foam See AL70300-0 <u>1</u> 00-****000 for seat cushion.		2½	22	A 489 B 550 C 624 D 673 E 795 F 917
	AL70331-0<u>1</u>00-****000 Key-Loc® Regent Back Cushion for Chair Upholstered, Cal 117 foam	Not available in vinyl or with moisture resistant liners.	2	10	A 666 B 715 C 774 D 813 E 910 F 1008
	AL70332-0<u>1</u>00-****000 Key-Loc® Regent Back Cushion for Right End of Loveseat or Sofa Upholstered, Cal 117 foam	Not available in vinyl or with moisture resistant liners.	2	10	A 628 B 677 C 736 D 775 E 873 F 970
	AL70333-0<u>1</u>00-****000 Key-Loc® Regent Back Cushion for Left End of Loveseat or Sofa Upholstered, Cal 117 foam	Not available in vinyl or with moisture resistant liners.	2	10	A 628 B 677 C 736 D 775 E 873 F 970
	AL70334-0<u>1</u>00-****000 Key-Loc® Regent Back Cushion for Center of Sofa Upholstered, Cal 117 foam	Not available in vinyl or with moisture resistant liners.	2	10	A 573 B 622 C 680 D 719 E 817 F 915
	AL70340-<u>K</u>100-****000 Casual Comfort/Tucson/Malibu/Pomona/Aurora/Haley Seat Cushion Upholstered, Cal 117 foam	Not available in vinyl or with moisture resistant liners.	1½	5	A 278 B 315 C 359 D 388 E 462 F 535
	AL70341-<u>K</u>100-****000 Casual Comfort/Tucson/Malibu/Pomona/Aurora/Haley Back Cushion Upholstered, Cal 117 foam	Not available in vinyl or with moisture resistant liners.	1½	3	A 178 B 215 C 259 D 288 E 362 F 435

An underlined character indicates there is a choice available. See pages 66-67 for selections and pricing. **** means that a fabric selection is required. List price for C.O.M. material is the same as Grade B.

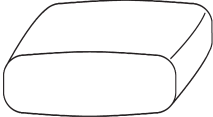
Lounge Seating Assemblies/Parts

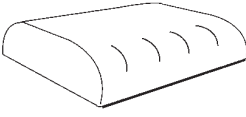
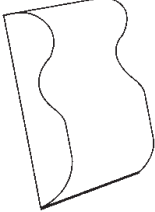
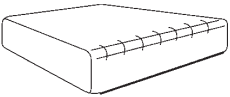
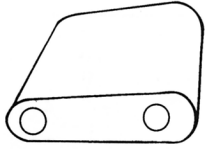
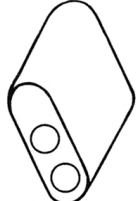
	Model/Description	Dimensions	Yd.	Wt.	List Price
	AL70355-0100-****000 Sabre/Bristol/Tarvos/Estel/ Eros Chair Cushion Upholstered, Cal 117 foam	Not available in vinyl or with moisture resistant liners. All fabric will be railroaded.	1	5	A 234 B 258 C 287 D 307 E 356 F 405
	AL70356-0100-****000 Sabre/Bristol/Tarvos/Estel/ Eros Sofa Cushion Upholstered, Cal 117 foam	Not available in vinyl or with moisture resistant liners. All fabric will be railroaded.	1	5	A 278 B 303 C 332 D 352 E 400 F 449
	AL70380-0100-****000 Silhouette Seat Cushion Upholstered, Cal 117 foam		1	5	A 367 B 392 C 420 D 440 E 489 F 538
	AL70381-0100-****000 Silhouette Back Cushion Upholstered, Cal 117 foam		2½	15	A 795 B 856 C 929 D 978 E 1100 F 1223
	AL70390-0100-****000 Bench Cushion Upholstered, Cal 117 foam		¾	5	A 228 B 247 C 268 D 284 E 320 F 357
	AL70400-0000-R***000 Integrity Seat Cushion 200 mil Roto-Mold			25	800
	AL70401-0000-R***000 Integrity Back Cushion 200 mil Roto-Mold			20	778

An underlined character indicates there is a choice available. See pages 66-67 for selections and pricing. **** means that a fabric selection is required. List price for C.O.M. material is the same as Grade B.

Lounge Seating Assemblies/Parts

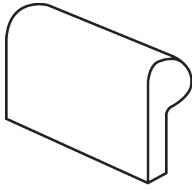
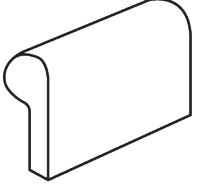
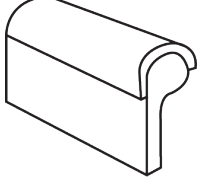
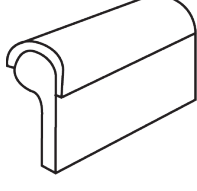
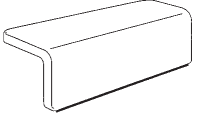
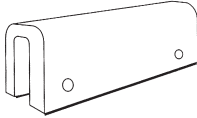
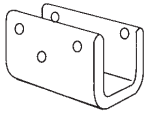
	Model/Description	Dimensions	Yd.	Wt.	List Price
	AL70705-0<u>1</u>00-****1A0 Ambassador Rolled Right Arm Upholstered, Cal 117 foam, oak feet, natural finish		2	20	A 595 B 644 C 703 D 742 E 839 F 937
	AL70706-0<u>1</u>00-****1A0 Ambassador Rolled Left Arm Upholstered, Cal 117 foam, oak feet, natural finish		2	20	A 595 B 644 C 703 D 742 E 839 F 937
	AL70707-0<u>1</u>00-****1A0 Regent Right Arm w/Pillow Upholstered, Cal 117 foam, oak feet, natural finish		2½	25	A 756 B 817 C 890 D 939 E 1062 F 1184
	AL70708-0<u>1</u>00-****1A0 Regent Left Arm w/Pillow Upholstered, Cal 117 foam, oak feet, natural finish		2½	25	A 756 B 817 C 890 D 939 E 1062 F 1184
	AL70800-0<u>1</u>00-****000 Ambassador Arm Pads Upholstered, Cal 117 foam, set includes two arm pads with six screws		1	3	A 289 B 314 C 343 D 363 E 412 F 460
	AL70801-0<u>1</u>00-****000 Safety Support Chair Arm Pads Upholstered, Cal 117 foam, set includes two arm pads with threaded rods and insert nuts		½	6	A 250 B 263 C 277 D 287 E 312 F 336
	AL70810-0000-0000000 L110 Ganging Hardware for 1⁵/₈" Thick Panels Includes one bent steel "U" bracket with set of four wood screws with washers			2	30

An underlined character indicates there is a choice available. See pages 66-67 for selections and pricing. **** means that a fabric selection is required. List price for C.O.M. material is the same as Grade B.

Lounge Seating Assemblies/Parts

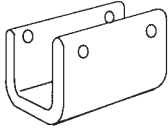
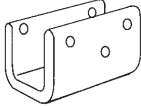
	Model/Description	Dimensions	Yd.	Wt.	List Price
	AL70811-0000-0000000 L119 Ganging Hardware for 1³/₄\" Thick Panels Includes one bent steel "U" bracket with set of four wood screws with washers			2	30
	AL70812-0000-0000000 L140 Ganging Hardware for 1³/₄\" Thick Panels Includes one bent steel "U" bracket with set of four wood screws with washers			2	30
	AL70813-0000-0000000 L630 Ganging Hardware for Paragon Modular Units Includes two bent steel "U" brackets with set of two bolts and six wood screws with washers			1	27

An underlined character indicates there is a choice available. See pages 66-67 for selections and pricing. **** means that a fabric selection is required. List price for C.O.M. material is the same as Grade B.

Lounge Seating Assemblies/Parts







Option Selection & Pricing Guide

Field Description:	Cushions (per seat)			Foam (per set)							Options
Field Position:	9			10							11
Selection Description:	N/A	Loose Cushions	Semi-attached Cushions	N/A	Cal 117	Cal 117, m.r.* Seat	Cal 117, m.r.* Back	Cal 133	Cal 133, m.r.* Seat	Cal 133, m.r.* Back	Heavy duty Inserts
Selection #:	0	K	L	0	1	2	3	4	5	6	S

AL70000				S							
AL70001				S							
AL70010				S							
AL70011				S							
AL70012				S							
AL70030				S							
AL70031				S							
AL70032				S							
AL70033				S							
AL70034				S							
AL70040		S	+34	S							
AL70041		S	+34	S							
AL70055				S							
AL70056				S							
AL70100				S							
AL70101				S							
AL70102				S							
AL70105				S							
AL70106				S							
AL70107				S							
AL70108				S							
AL70120				S							
AL70121				S							
AL70130				S							
AL70131				S							
AL70140				S							
AL70141				S							
AL70250				S							
AL70251				S							
AL70300	S				S	+66		+50	+116		+45
AL70301	S				S		+66	+50		+116	



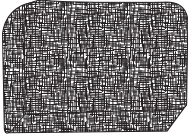

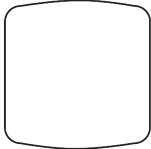
*m.r. = Moisture resistance

X Chair Seating Assemblies/Parts

	Model/Description	Dimensions	Yd.	Wt.	List Price
	AX76030-0100-****000 X025 Seat Cushion Upholstered, Cal 117 foam		$\frac{3}{4}$	5	A 189 B 208 C 229 D 245 E 282 F 318
	AX76040-0100-****000 X043 Seat Cushion Upholstered, Cal 117 foam		$\frac{3}{4}$	5	A 139 B 158 C 179 D 195 E 232 F 268
	AX76041-0100-****000 X043 Back Cushion Upholstered, Cal 117 foam		$\frac{3}{4}$	3	A 128 B 147 C 168 D 184 E 220 F 257
	AX76050-0100-****000 X045 Seat Cushion Upholstered, Cal 117 foam		$\frac{3}{4}$	5	A 162 B 180 C 202 D 217 E 254 F 290
	AX76051-0100-****000 X045 Back Cushion Upholstered, Cal 117 foam		$\frac{3}{4}$	3	A 145 B 164 C 185 D 200 E 237 F 274
	AX76060-0100-****000 (narrow) AX76062-0100-****000 (wide) X030 Seat Cushion Upholstered, Cal 117 foam		$\frac{3}{4}$	5	A 134 B 153 C 174 D 189 E 226 F 263
	AX76064-0100-****000 X030 Back Cushion Upholstered, Cal 117 foam		$\frac{3}{4}$	3	A 145 B 164 C 185 D 200 E 237 F 274

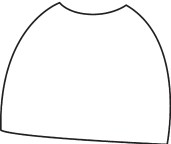
An underlined character indicates there is a choice available. See page 70 for selections and pricing. **** means that a fabric selection is required.
List price for C.O.M. material is the same as Grade B.

X Chair Seating Assemblies/Parts

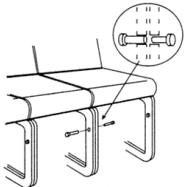
	Model/Description	Dimensions	Yd.	Wt.	List Price
	AX76090-01<u>00</u>-****000 X050 Seat Cushion Upholstered, Cal 117 foam		$\frac{3}{4}$	1	A 150 B 169 C 190 D 206 E 243 F 279
	AX76091-01<u>00</u>-****000 X050 Back Cushion Upholstered, Cal 117 foam		$\frac{3}{4}$	1	A 134 B 153 C 174 D 189 E 226 F 263
	AX76140-01<u>00</u>-****000 X140, X142 Seat Cushion Upholstered, Cal 117 foam		$\frac{3}{4}$	5	A 139 B 158 C 179 D 195 E 232 F 268
	AX76141-01<u>00</u>-****000 X140, X142 Back Cushion Upholstered, Cal 117 foam		$\frac{3}{4}$	3	A 128 B 147 C 168 D 184 E 220 F 257
	48023-1A (Narrow) 48033-1A (Wide) X030 Wood Seat Oak, natural finish			4	120 120
	AX76400-0000-0000000 X030 Ganging Hardware Set of four cap screws and insert nuts				28 per chair connection

An underlined character indicates there is a choice available. See page 70 for selections and pricing. **** means that a fabric selection is required. List price for C.O.M. material is the same as Grade B.

X Chair Seating Assemblies/Parts

Option Selection & Pricing Guide

Field Description:	Foam (per set)						
Field Position:	10						
Selection Description:	N/A	Cal 117	Cal 117, m.r.* Seat	Cal 117, m.r.* Back	Cal 133	Cal 133, m.r.* Seat	Cal 133, m.r.* Back & Seat
Selection #:	0	1	2	3	4	5	6

AX76020		S	+42		+36	+78	
AX76021		S		+42	+36		+78
AX76030		S	+42		+36	+78	
AX76040		S	+42		+36	+78	
AX76041		S		+42	+36		+78
AX76050		S	+42		+36	+78	
AX76051		S		+42	+36		+78
AX76062		S	+42		+36	+78	
AX76064		S		+42	+36		+78
AX76090		S	+42		+36	+78	
AX76091		S		+42	+36		+78
AX76140		S	+42		+36	+78	
AX76141		S		+42	+36		+78
48033-1A		S					
AX76400		S					

*m.r. = Moisture resistance

Wall Attachment Diagram

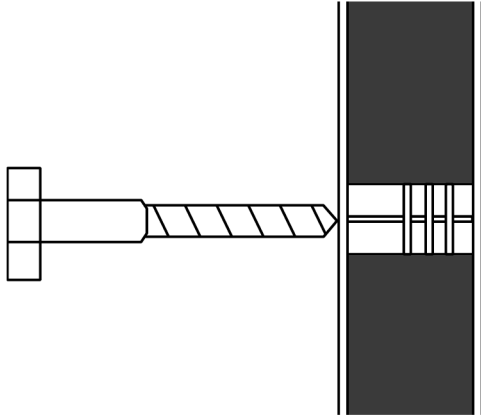

Two-Piece Attachment Diagram

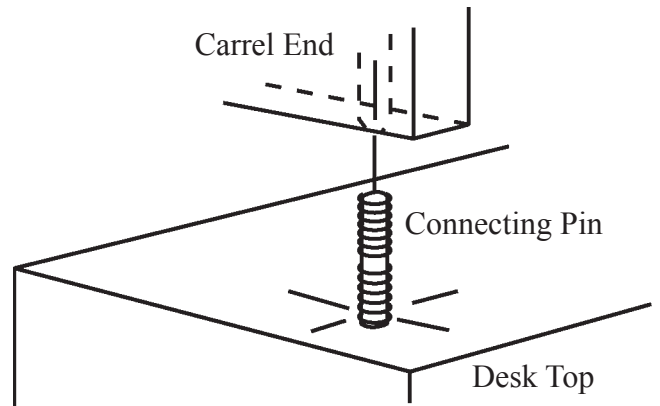

Full Height Adjustable Loft Bed

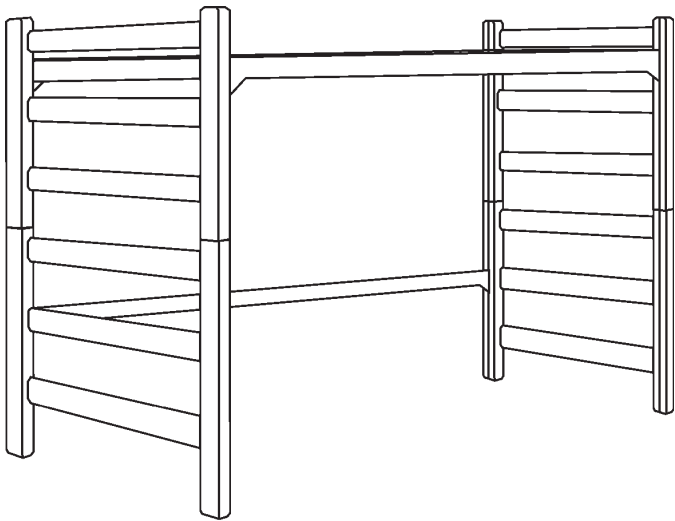

Full Height Adjustable Loft Bed with Desk and Dresser

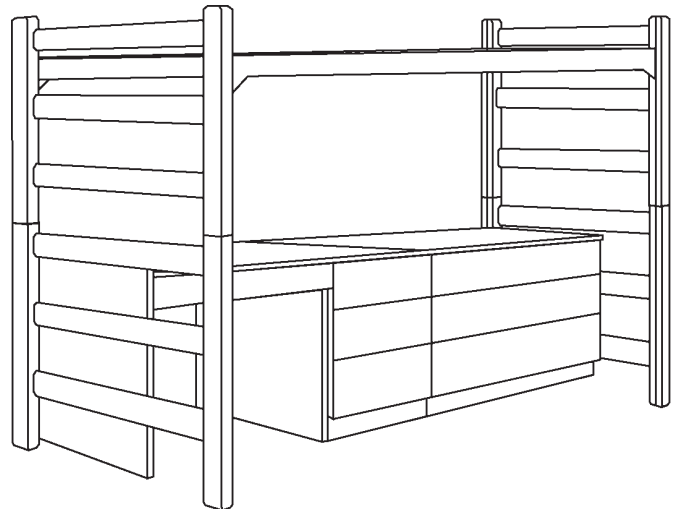

Adjustable Low Loft Bed

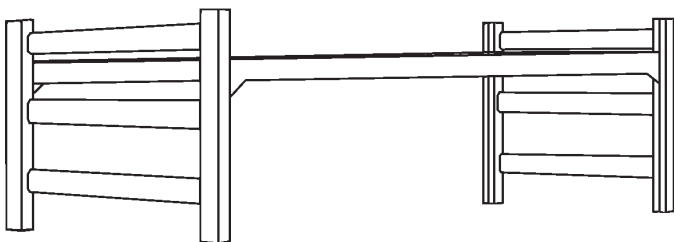

Limited to the 48 Contiguous States

Blanket Wrapped Freight Rates for Trailer Loads

Please contact Blockhouse at 1-800-346-1126 to verify rates.

11 Piece Minimum Quantity Order

Revised 5/24/11

Zone (see map below)	Cube Rate between 01-1400 Cubes	Cube Rate between 1401 to (Full Truck)	Full Truck Rate 2800 Cubes
A	\$1.27 per Cube	\$1.00 per Cube	\$2,180 max per trailer
B	\$1.55 per Cube	\$1.21 per Cube	\$2,700 max per trailer
C	\$2.16 per Cube	\$1.71 per Cube	\$3,738 max per trailer
D	\$2.79 per Cube	\$2.22 per Cube	\$4,881 max per trailer
E	\$3.42 per Cube	\$2.70 per Cube	\$5,917 max per trailer
F	\$4.37 per Cube	\$3.44 per Cube	\$7,576 max per trailer

\$75.00 Drop Charge must be added to above rates.

\$75.00 Drop Charge must be added to above rates.

Full Truckload Rate - NO Drop Charge needed.

EXAMPLE: Assumption is that you are shipping to Zone "A". Your total order consists of 1600 Cubes. Since the Cubes fall into the (1401 to Full Truck) range, (SEE ABOVE CHART), the price per cube is \$1.00. Multiply the \$1.00 per cube x 1600 (order total cube) which should equal \$1,600.00. Add the drop charge of \$75.00, which give you a total rate of \$1,675.00.

10 PIECES OR LESS: Contact factory for freight charges.

ZONE

STATE

A	NH, VT, MA, CT, RI, NY, PA, MD, NJ, DE
B	OH, WV, VA, NC, SC, ME
C	MI, IN, WI, IL, KY, TN, GA, AL, MS, FL
D	MN, IA, MO, AR, LA, NE, KS, OK, TX
E	MT, WY, UT, CO, NM, ND, SD
F	WA, OR, ID, CA, NV, AZ

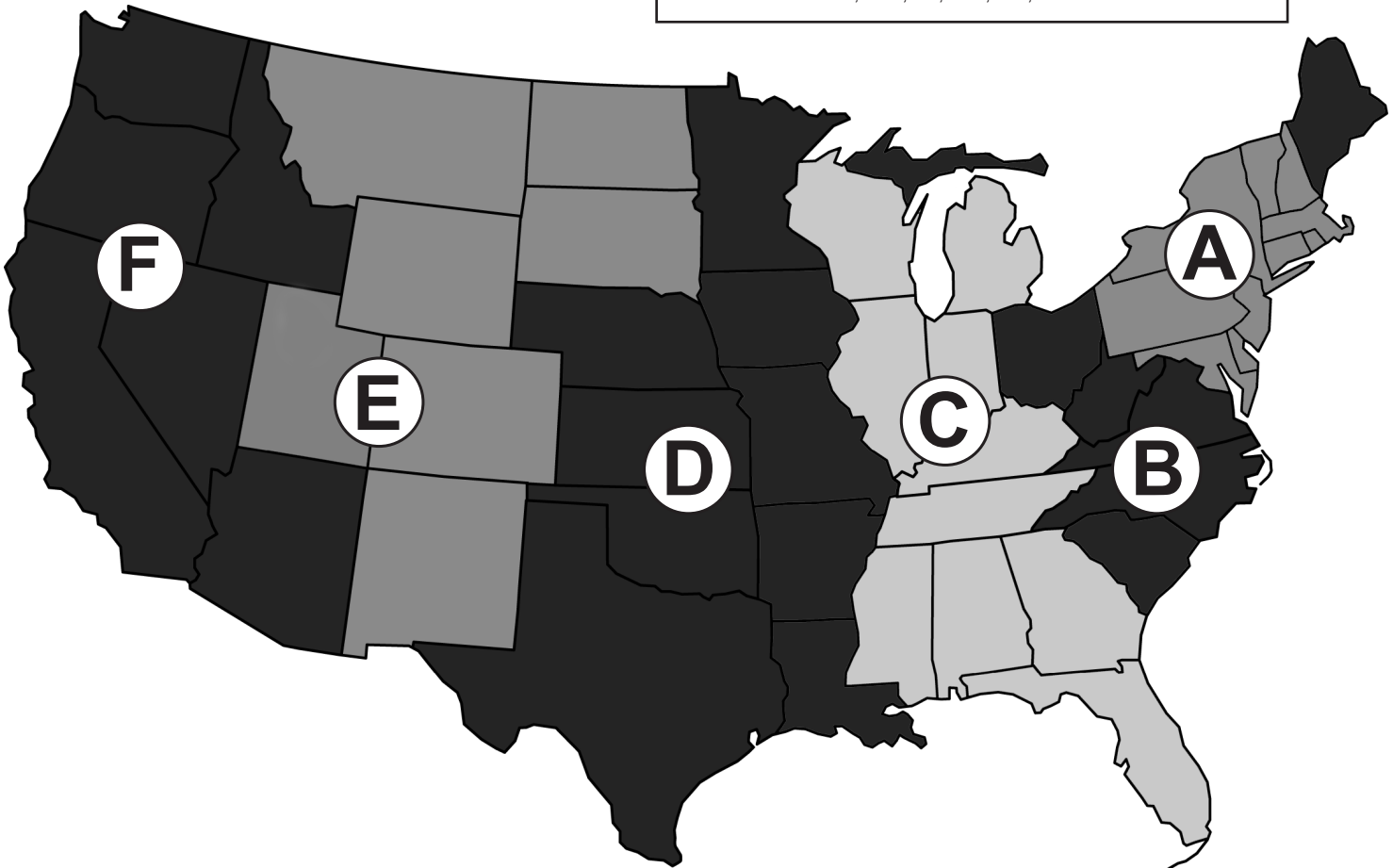



BLOCKHOUSE CONTRACT FURNITURE COMPANY

3285 Farmtrail Road • York, PA 17406

800.346.1126 • fax: 717.767.8939 • www.blockhouse.com